



## Profipress G-Schiebemuffe mit SC-Contur

- Pressanschlüsse

### Ausstattung

Dichtelemente HNBR

**Modell 2615.5**

**Artikel 394 196**

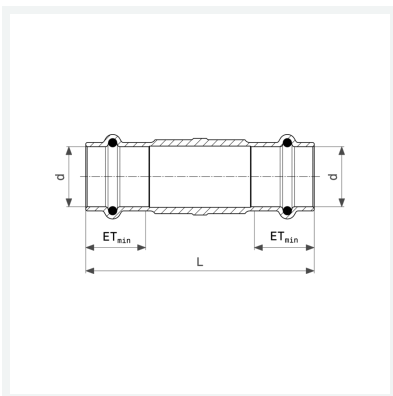

## Eigenschaften

Rohraußendurchmesser	d	28
Länge	L	95 mm
Einstecktiefe minimal	ETmin	24 mm
Gewicht	171,8 g	
Volumen	248,64 cm <sup>3</sup>	
Werkstoff	Rotguss	