

X-Line

33142290000 Waschtischunterbau

PRODUKT

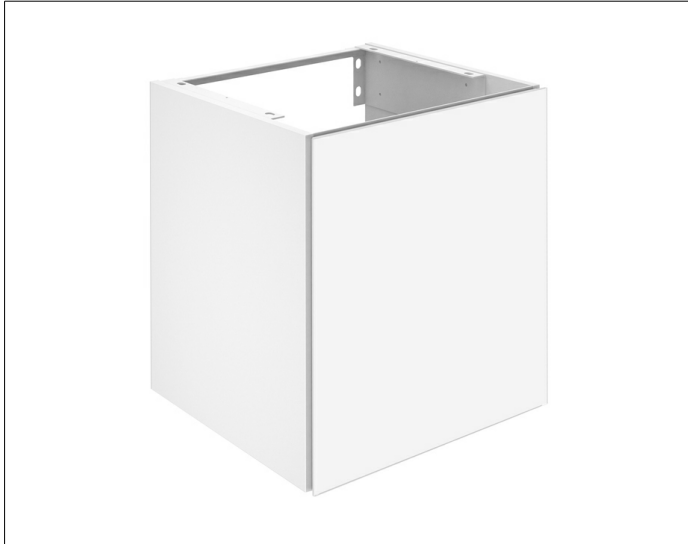

ZEICHNUNG

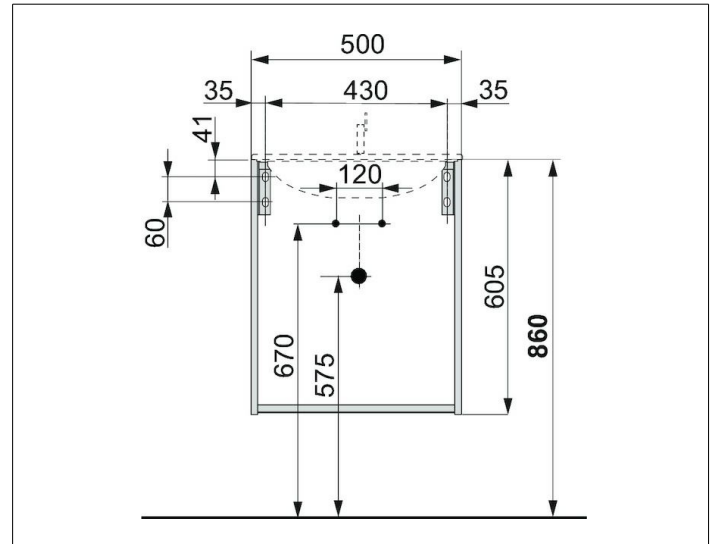

OBERFLÄCHE

inox/inox

ABMESSUNG

500 x 605 x 490 mm