

Edition 400

31582280100 Waschtischunterbau

PRODUKT



ZEICHNUNG

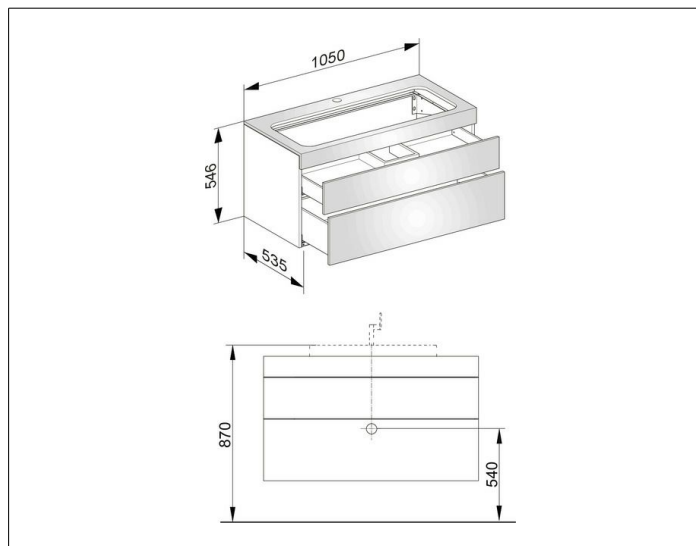

OBERFLÄCHE

cashmere/Glas cashmere satiniert

ABMESSUNG

1050 x 546 x 535 mm