

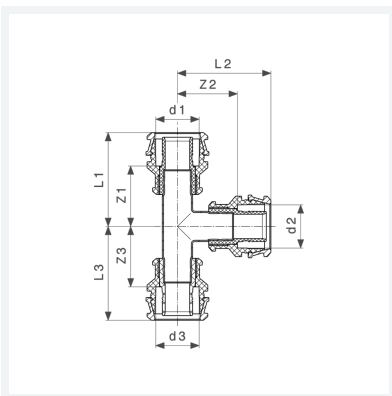

**Raxinox-T-Stück
mit SC-Contur**
- Pressanschlüsse
Modell 4418

Artikel 724 221



Eigenschaften

Rohraußendurchmesser 1	d1	20
Rohraußendurchmesser 2	d2	16
Rohraußendurchmesser 3	d3	16
Z-Maß 1	Z1	28 mm
Z-Maß 2	Z2	29 mm
Z-Maß 3	Z3	28 mm
Länge 1	L1	43 mm
Länge 2	L2	43 mm
Länge 3	L3	42 mm
Gewicht	66,41 g	



**Raxinox-T-Stück
mit SC-Contur
Modell 4418
Artikel 724 221**

Eigenschaften

Volumen	207,2 cm ³
Werkstoff	Stahl nichtrostend