

# Happy D.2 Plus

# # HP 4638

## Montageanleitung

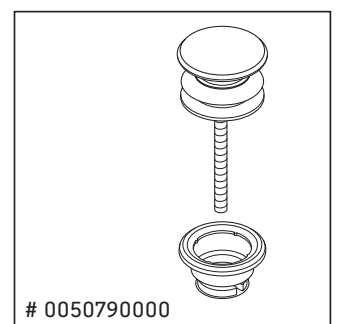
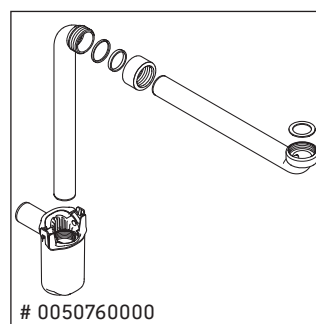
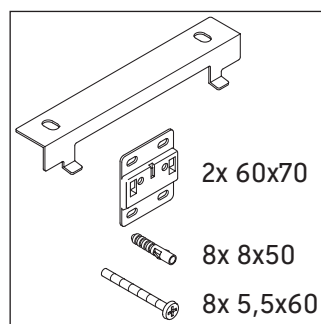
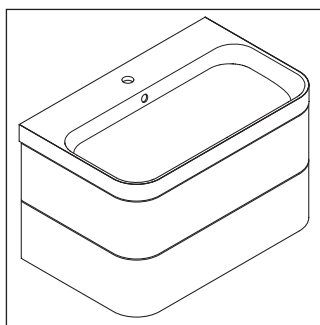
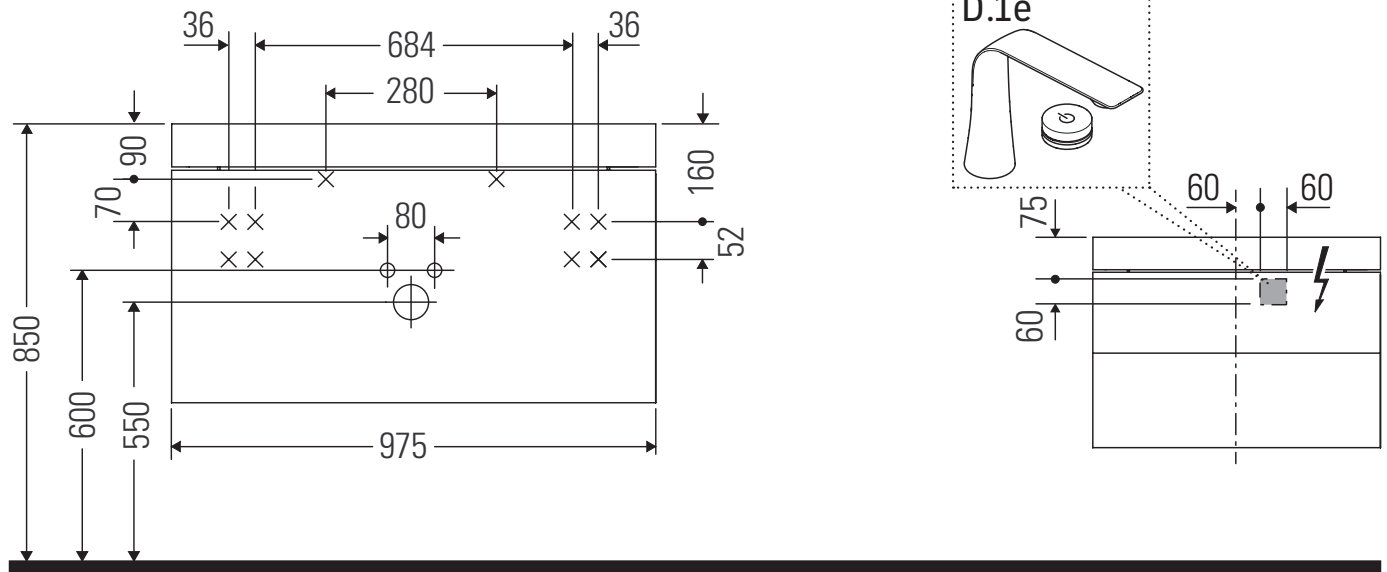

## Verwendungshinweise

Die Badmöbelserie entspricht den gültigen Normen und Richtlinien zum Zeitpunkt der Auslieferung und ist für den Einsatz in Bädern konzipiert. Eine direkte Benetzung mit Wasser z. B. beim Duschen ist zu vermeiden.

Technische Verbesserungen und optische Veränderungen an den abgebildeten Produkten behalten wir uns vor.



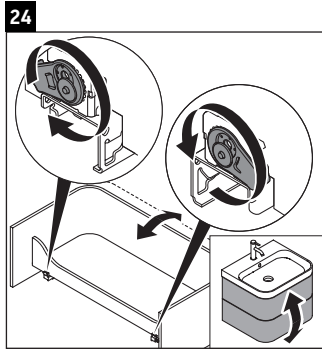
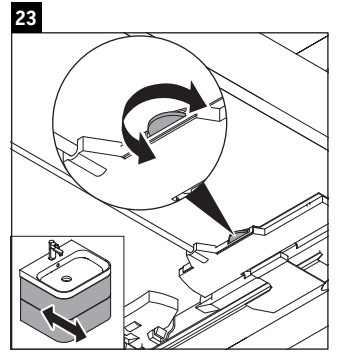
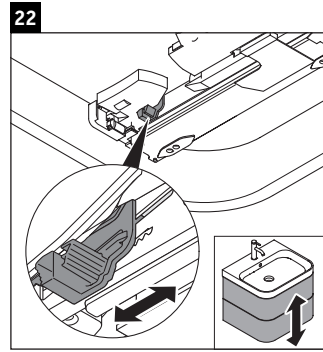
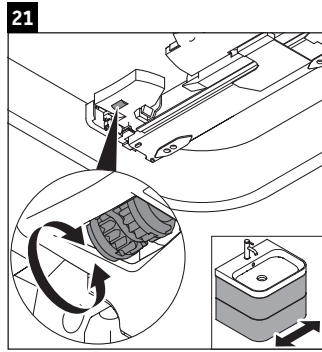
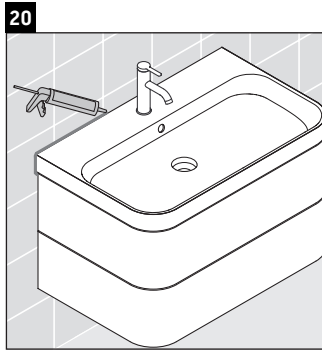

**Duravit AG**  
P.O. Box 240  
Werderstr. 36  
78132 Hornberg  
Germany  
Phone +49 78 33 70 0  
Fax +49 78 33 70 289  
info@duravit.com  
www.duravit.com



Order no. HP4638/20.07.2