

Edition 400

31582860100 Waschtischunterbau

PRODUKT



ZEICHNUNG

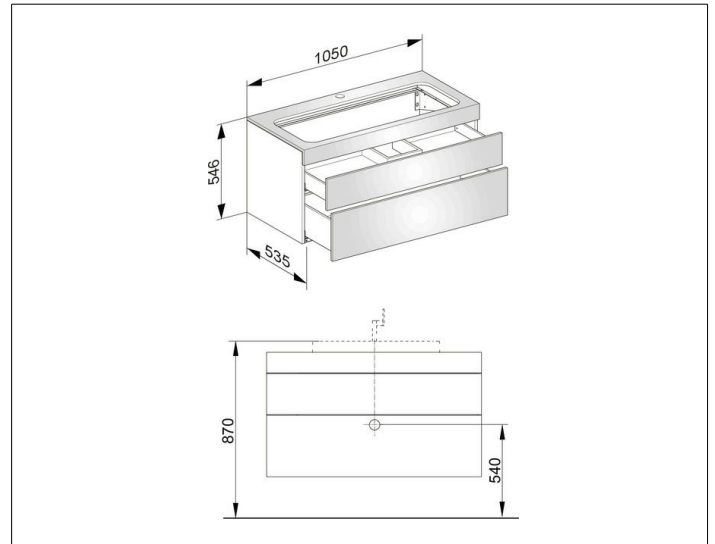

OBERFLÄCHE

Eiche anthrazit/Eiche anthrazit

ABMESSUNG

1050 x 546 x 535 mm