

hansgrohe

- DE** Montageanleitung
- FR** Instructions de montage
- EN** assembly instructions
- IT** Istruzioni per Installazione
- ES** Instrucciones de montaje
- NL** Handleiding
- DK** Monteringsvejledning
- PT** Manual de Instalação
- PL** Instrukcja montażu
- CS** Montážní návod
- SK** Montážny návod
- ZH** 组装说明
- RU** Инструкция по монтажу
- HU** Szerelési útmutató
- FI** Asennusohje
- SV** Monteringsanvisning
- LT** Montavimo instrukcijos
- HR** Uputstva za instalaciju
- TR** Montaj kılavuzu
- RO** Instrucțiuni de montare
- EL** Οδηγία συναρμολόγησης
- SL** Navodila za montažo
- ET** Paigaldusjuhend
- LV** Montāžas instrukcija
- SR** Uputstvo za montažu
- NO** Montasjeveiledning
- BG** Инструкция за употреба
- SQ** Udhëzime rreth montimit
- AR** تعليمات التجميع
- JP** 施工説明書

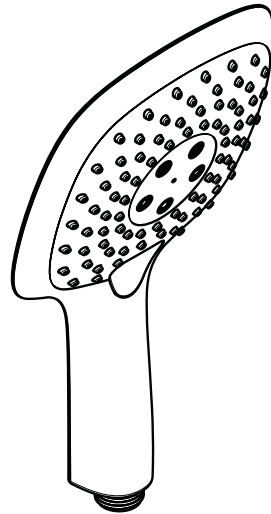

PuraVida

28557000 / 28557400

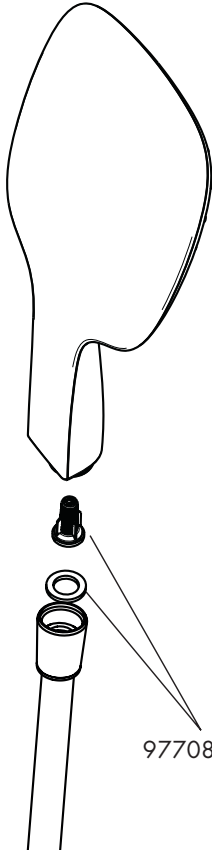

97708000

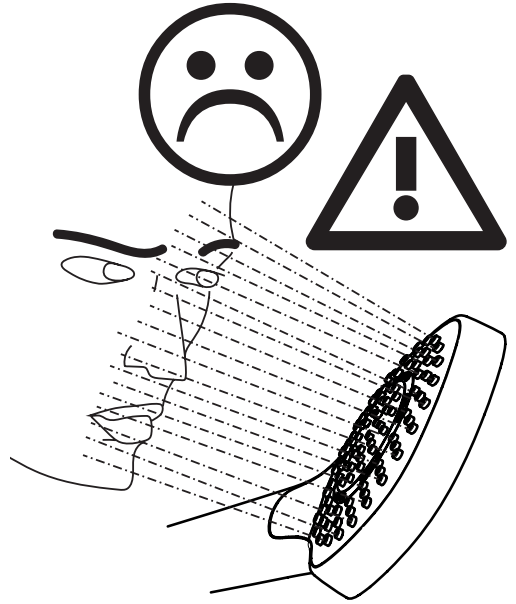

P	max. 0,6 MPa 6 bar	0,15 - 0,4 MPa 1,5 - 4 bar	
----------	--------------------------	-------------------------------	--



T	max. 60 °C	40 - 50 °C	
----------	---------------	------------	--

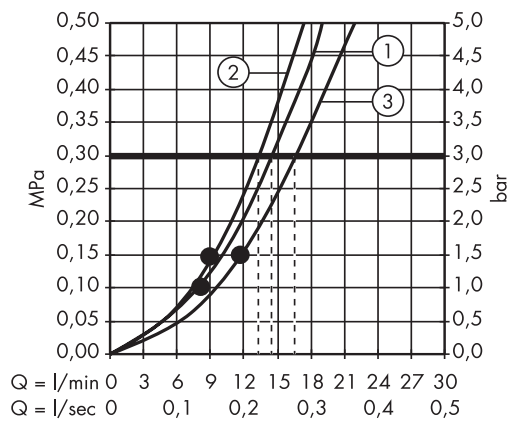
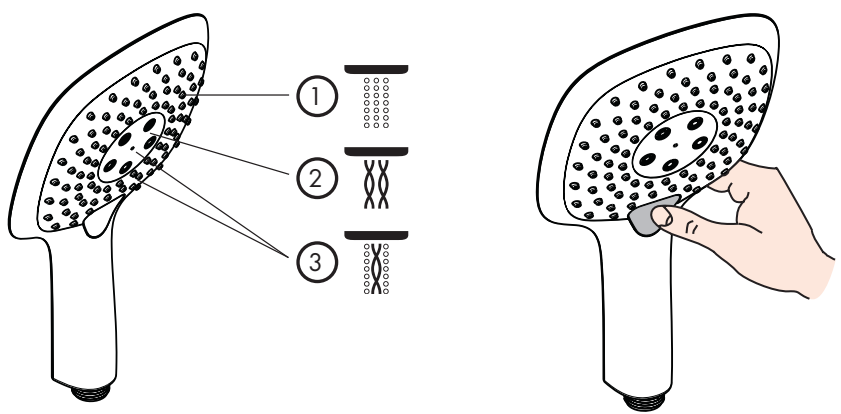
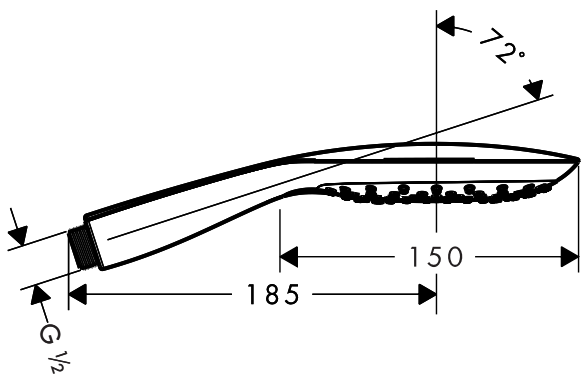

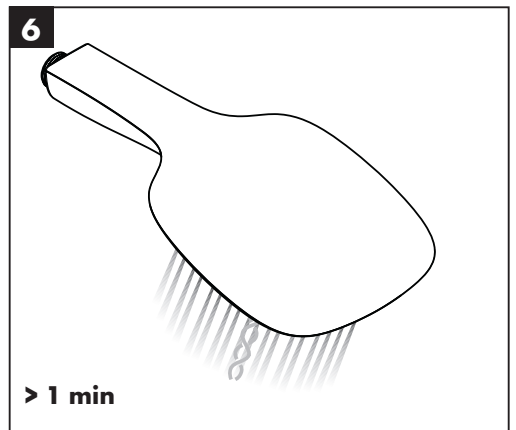
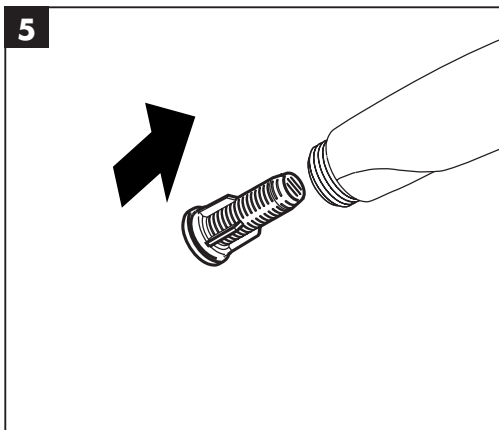
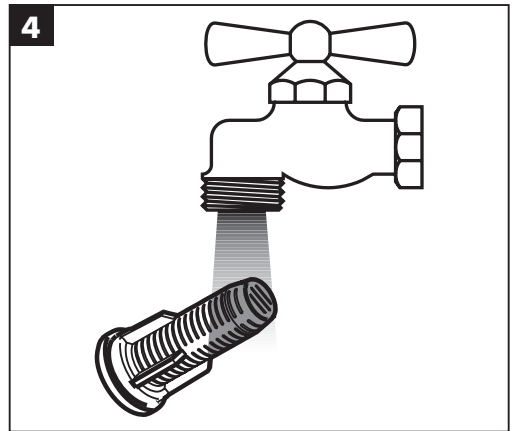
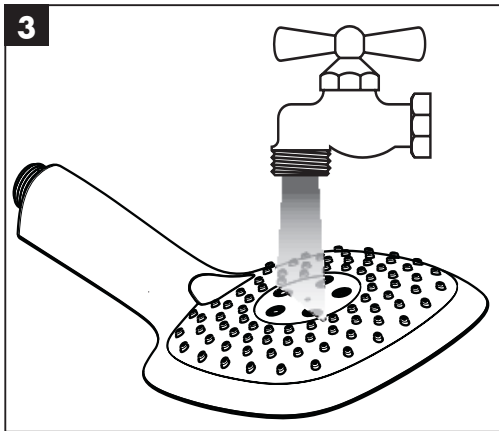
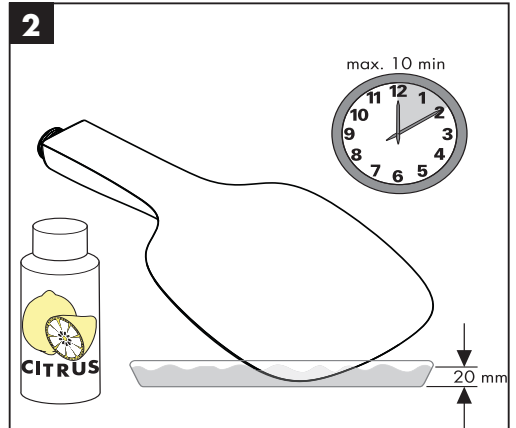
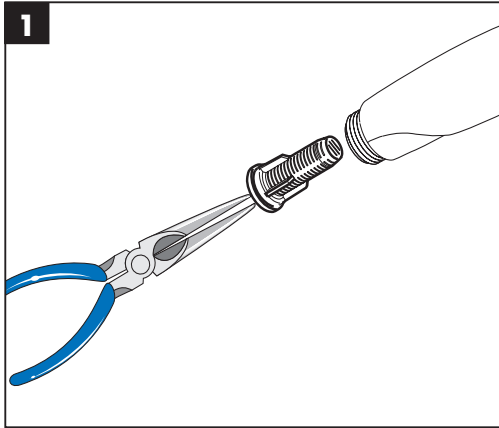



- DE** Reinigungsempfehlung / Garantie / Kontakt
- FR** Recommandation pour le nettoyage / Garanties / Contact
- EN** Cleaning recommendation / Warranty / Contact
- IT** Raccomandazione di pulizia / Garanzia / Contatto
- ES** Recomendaciones para la limpieza / Garantía / Contacto
- NL** Aanbevelingen inzake reiniging / Garantie / Contact
- DK** Rensning, anbefaling / Garanti / Kontakt
- PT** Recomendações de limpeza / Garantia / Contacto
- PL** Zalecenie dotyczące pielęgnacji / Gwarancja / Kontakt
- CS** Doporučení k čištění / Záruka / Kontakt
- SK** Odporúčania pre čistenie / Záruka / Kontakt
- ZH** 清洁指南 / 担保 / 接触
- RU** Рекомендации по очистке / Гарантия / Контакты
- FI** Puhdistussuositus / Takuu / Kosketus
- SV** Rengöringsrekommendationer / Garanti / Contacto
- LT** Valymo rekomendacijos / Garantija / Kontaktai
- HR** Preporuke za čišćenje / Garancija / Kontakt
- TR** Temizleme önerisi / Garanti / Temas
- RO** Recomandări pentru curățare / Garanție / Contact
- EL** Σύσταση καθαρισμού / Εγγύηση / επαφή
- SL** Priporočilo za čiščenje / Garancija / Kontakt
- ET** Puhastussuositused / Garantii / Kontakt
- LV** Tīrīšanas ieteikumi / Garantija / Kontakti
- SR** Preporuke za čišćenje / Garancija / Kontakt
- NO** Anbefaling for rengjøring / Garanti / Kontakt
- BG** Препоръка за почистване / Гаранция / Контакт
- SQ** Këshilla rreth pastrimit / Garancia / Kontakt
- KO** 세정시 권장사항 / 품질보증 / 접촉
- AR** توصيات التنظيف / الضمان (الولايات المتحدة الأمريكية) / اتصال
- HU** Tisztítási tanácsok / Garancia / érintkezés
- JP** お手入れの方法 / 保証について / ご連絡先



[www.hansgrohe.com/
cleaning-recommendation](http://www.hansgrohe.com/cleaning-recommendation)

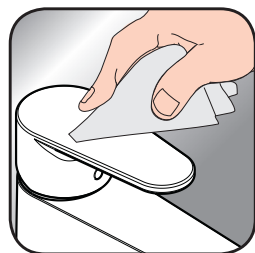

[www.hansgrohe.com/
cleaning-recommendation](http://www.hansgrohe.com/cleaning-recommendation)



[www.hansgrohe.com/
cleaning-recommendation](http://www.hansgrohe.com/cleaning-recommendation)



[www.hansgrohe.com/
cleaning-recommendation](http://www.hansgrohe.com/cleaning-recommendation)

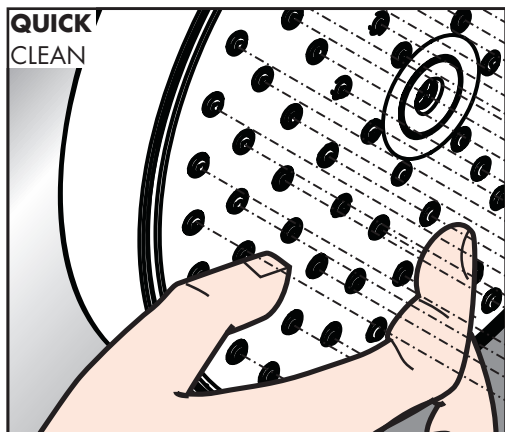

- DE** Einfach sauber: Kalk lässt sich von den Noppen ganz leicht abrubbeln.
- FR** La propreté en toute simplicité: les dépôts formés sur les buses élastiques en silicone s'éliminent par un simple passage de la main.
- EN** Just clean: simply rub over the spray nozzles to remove lime scale.
- IT** Facile da pulire: Il calcare viene eliminato semplicemente dagli ugelli elastici in silicone.
- ES** Fácil aseó: La cal se puede retirar sencillamente frotando con los dedos de las toberas elásticas de silicona.
- NL** Eenvoudig schoon: Kalk kan eenvoudig van de noppen worden gewreven.
- DK** Enkel rengøring: Det er let at fjerne kalkaflejringer fra stråledyserne.
- PT** Simplesmente limpo: o calcário pode ser simplesmente retirado das saiências através de fricção.
- PL** Po prostu czysto: Pęczki można całkiem łatwo oczyścić z kamienia.
- CS** Jednoduše čistě: Vapenné usazeniny můžete z popků snadno odstranit oříháním.
- SK** Jednoducho čistý: Vodný kameň sa dá zo štetín celkom ľahko odstrániť.
- ZH** 清洁: 只需要揉搓花洒表面的出水孔即可去除水垢。
- RU** Простота чистки: известь очень легко стирается с утолщений.
- FI** Yksinkertaisesti puhdas: kalkin voi helposti hieroa irti nypystä.
- SV** Enkelt att göra rent: det är lätt att ta bort kalk från nopporna.
- LT** Paprasta švara: kalkės lengvai nugrandomos nuo kilpos.
- HR** Jednostavno čisto: Kamenac se sasvim lako uklanja s izbočina.
- TR** Sadece temiz: Kireç, düğümlerle kolayca ovalanabilir.
- RO** Pur și simplu curat: Calcarul se îndepărtează ușor de pe noduri prin frecare.
- EL** Απλά τέλεια καθαριότητα: Τα άλατα μπορούν να αφαιρεθούν με μεγάλη ευκολία από τα στόμια.
- SL** Preprosto čisto: arpenec se z lahkoto podrgne z vozličkov.
- ET** Lihtsalt puhas: luoja saab nuppudel lihtsalt maha hõõruda.
- LV** Vienkārša tīrīšana: kaļķis no izvirzījumiem ir viegli norubināms.
- SR** Jednostavno čisto: Kamenac se sasvim lako skida sa izbočina.
- NO** Simpelten ren: Ved å gnikke er det lett å fjerne kalk fra nuppene.
- BG** Просто чисто: Варовикът лесно може да се изтърси от удебеленията.
- SQ** Thjesht dhe pastër. Mbetjet gëlqerore mund të hiqen me fërkim të lehtë.
- AR** إنه سهل التنظيف، حيث يسقط الجير بسهولة شديدة من الأجزاء الناتئة
- HU** Egyszerűen tisztza: a vízkő egészen könnyen ledörzsölhető a csomókról.
- JP** 清掃が簡単: カルキは突起部から簡単にこすり落とすことができます。



hansgrohe

Hansgrohe · AuestraÙe 5 · 9 · D-77761 Schiltach · Telefon +49 (0) 78 36/51-1282 · Telefax +49 (0) 7836/511440
E-Mail: info@hansgrohe.com · Internet: www.hansgrohe.com

04/2020
9.04892.01