

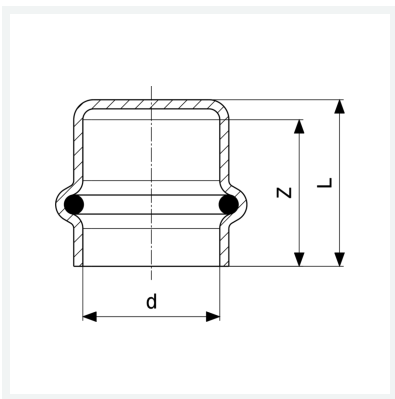

**Profipress-Kappe
mit SC-Contur**
- Pressanschluss
Ausstattung
Dichtelement EPDM
Modell 2456

Artikel 444 075



Eigenschaften

Rohraußendurchmesser	d	14
Z-Maß	Z	21 mm
Länge	L	24 mm
Gewicht	20,5 g	
Volumen	41,44 cm ³	
Werkstoff	Kupfer	