

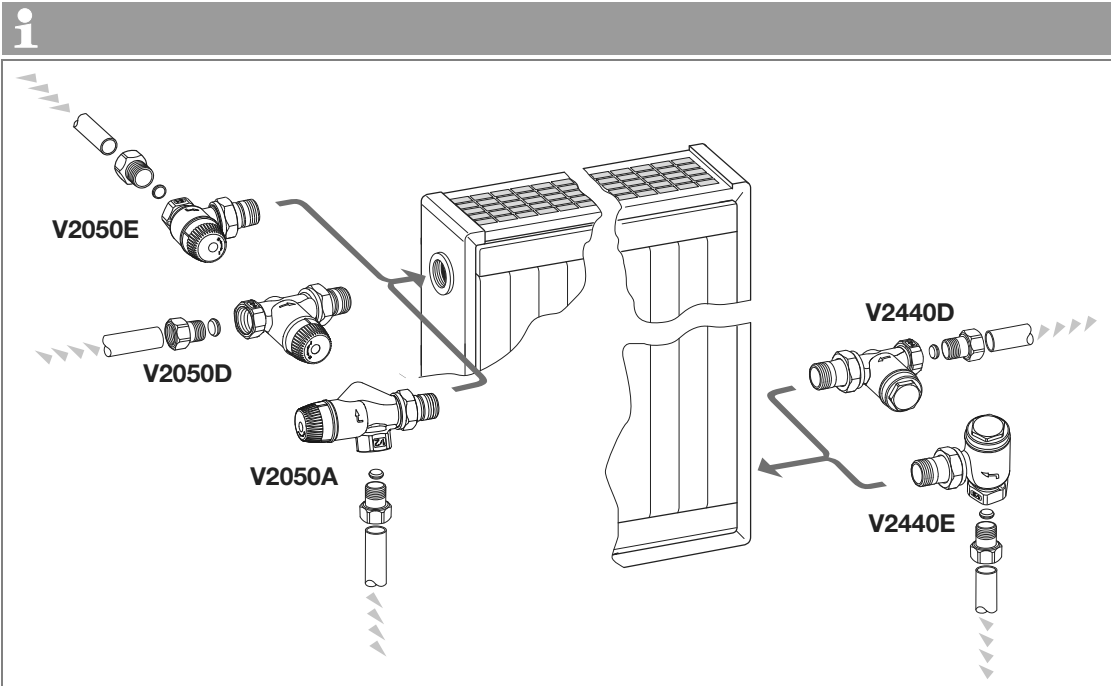

V2050 Varia V2440 Veramax

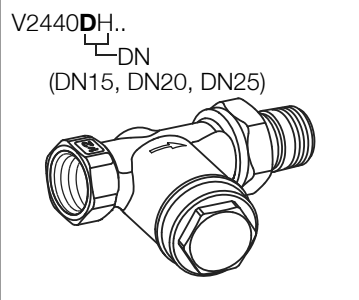

<p>2 - 130°C Max. 10 bar Δp_{max} 0.3 bar</p>	<p>V2050</p>	<p>V2440</p>
--	--------------	--------------

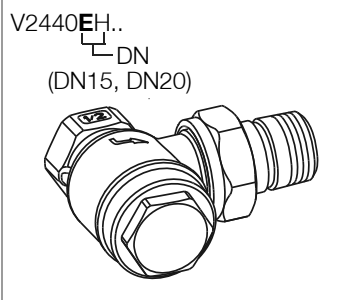
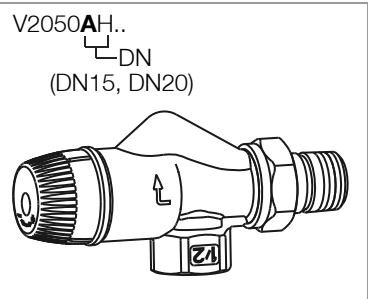
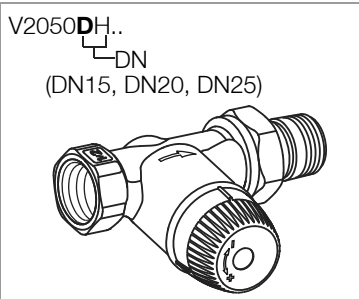
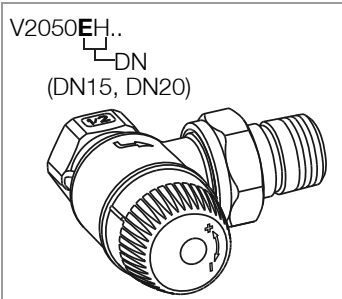

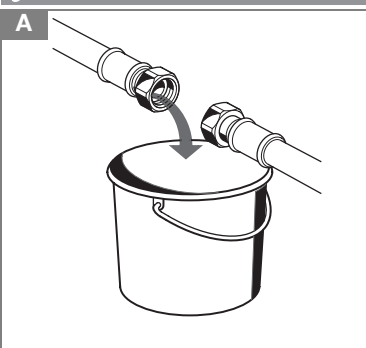

A 

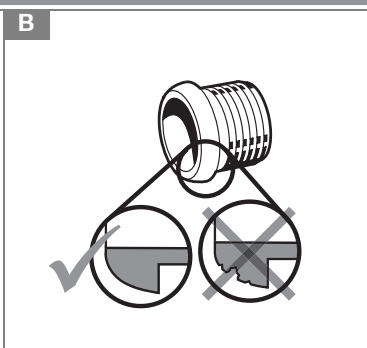
B 

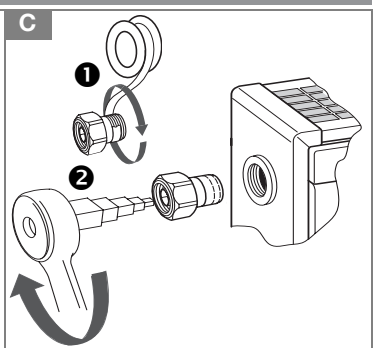
C 

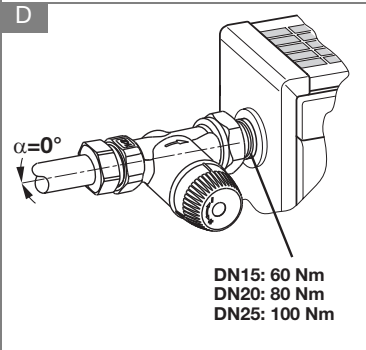
D  $\alpha=0^\circ$
DN15: 60 Nm
DN20: 80 Nm
DN25: 100 Nm

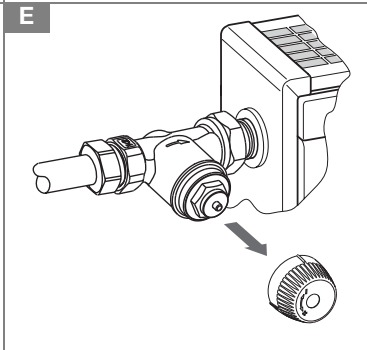
E 

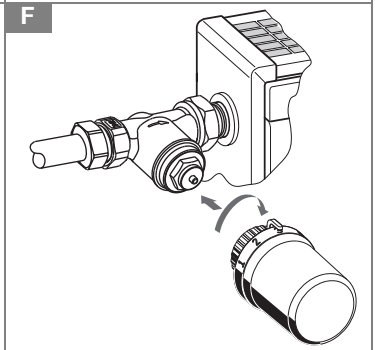
F 

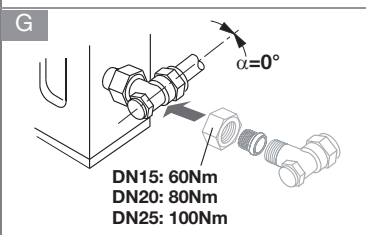
G  $\alpha=0^\circ$
DN15: 60Nm
DN20: 80Nm
DN25: 100Nm

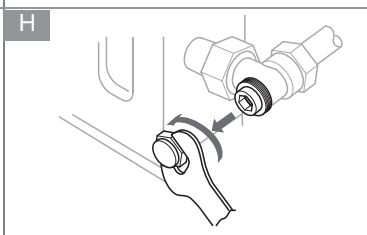
H 

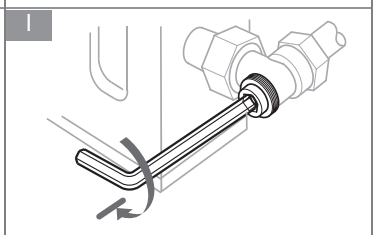
I 

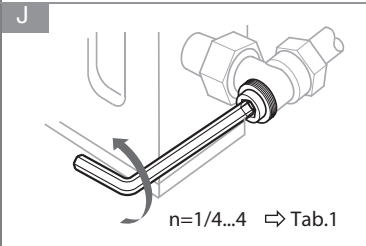
J  $n=1/4...4 \Rightarrow \text{Tab.1}$

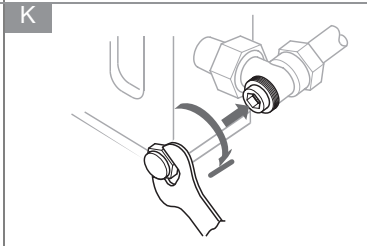
K 

Tab. 1: kvs (V2440...A)

n	1/4	1/2	1	1 1/2	2	3	4
D15	0.1	0.2	0.6	1.0	1.5	2.6	3.5
E15	0.1	0.2	0.6	1.0	1.5	3.5	5.0
D20	0.1	0.2	0.6	1.0	1.5	3.5	4.5
E20	0.1	0.2	0.6	1.0	1.5	3.5	5.0
D25	0.1	0.2	0.6	1.0	1.5	3.5	4.6

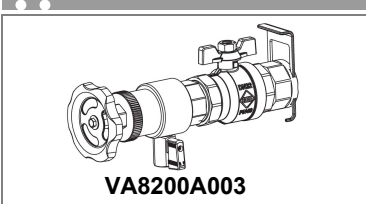

VA8200A003 

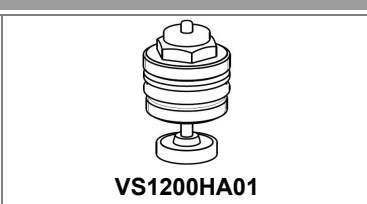
VS1200HA01 

T3019/T3019WO 

For more information
homecomfort.resideo.com/europe



Ademco 1 GmbH
 Hardhofweg 40
 74821 MOSBACH
 GERMANY
 Phone: +49 6261 810
 Fax: +49 6261 81309

Manufactured for and on behalf of the
 Pittway Sarl, La Pièce 4, 1180 Rolle, Switzerland
 by its Authorised Representative Ademco 1 GmbH
 MU2H-2048GE25 R0121
 Subject to change
 © 2021 Pittway Sarl. All rights reserved.
 This document contains proprietary information of
 Pittway Sarl and its affiliated companies and is
 protected by copyright and other international
 laws. Reproduction or improper use without specific
 written authorisation of Pittway Sarl is strictly
 forbidden. The Honeywell Home trademark is used
 under license from Honeywell International Inc.

Honeywell Home