

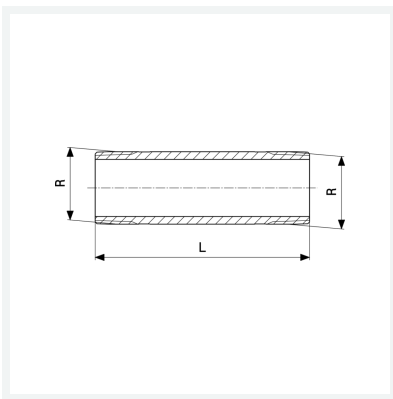

Langnippel
- R-Gewinde
Modell 3530

Artikel 650 964



Eigenschaften

Länge	L	110
Außengewinde kegelig	R	$\frac{3}{4}$
Länge	L	110 mm
Gewicht	229 g	
Volumen	177,6 cm ³	
Werkstoff	Rotguss oder Siliziumbronze	