

Edition 400

31582380100 Waschtischunterbau

**PRODUKT**



**ZEICHNUNG**

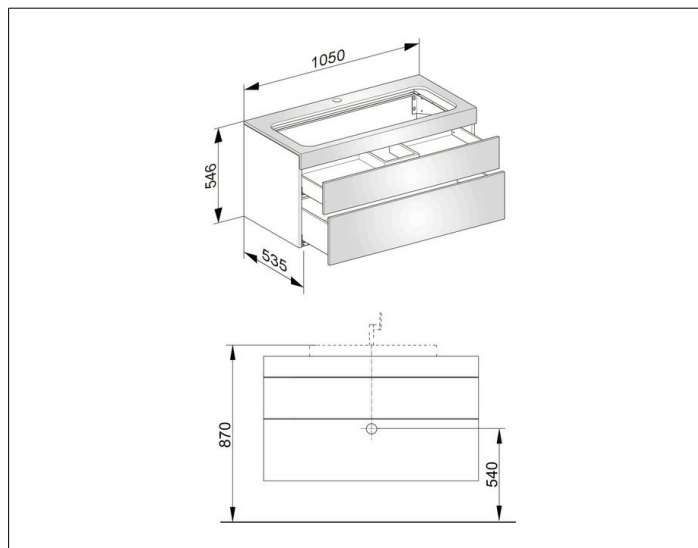

**OBERFLÄCHE**

weiß/weiß

**ABMESSUNG**

1050 x 546 x 535 mm