

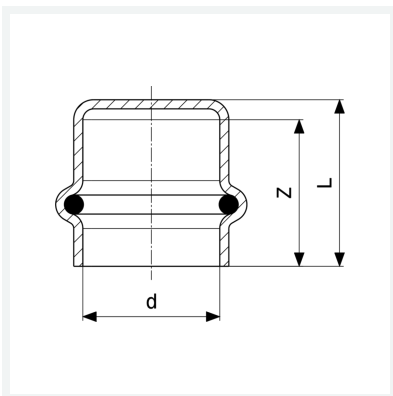

**Profipress-Kappe
mit SC-Contur**
- Pressanschluss
Ausstattung
Dichtelement EPDM
Modell 2456

Artikel 349 356



Eigenschaften

VdS-Zulassung	VdS	✓
Rohraußendurchmesser	d	22
Z-Maß	Z	25 mm
Länge	L	28 mm
Gewicht	38,5 g	
Volumen	62,16 cm ³	
Werkstoff	Kupfer	