

Edition 400

31582700100 Waschtischunterbau

PRODUKT



ZEICHNUNG

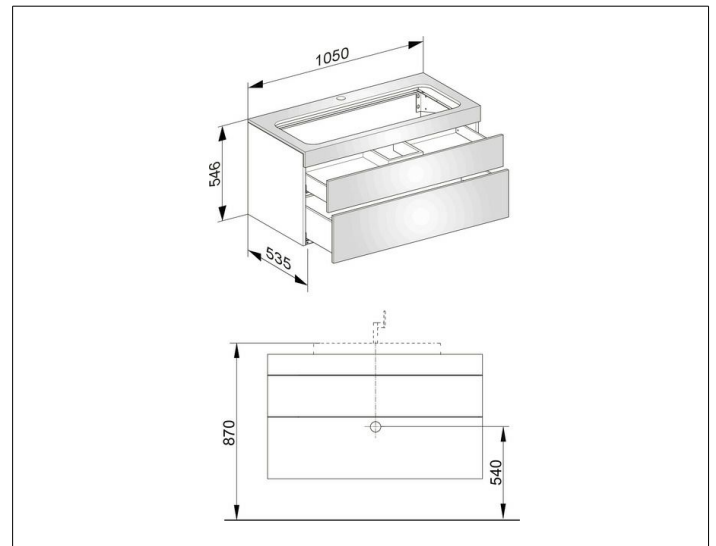

OBERFLÄCHE

weiß/Glas anthrazit klar

ABMESSUNG

1050 x 546 x 535 mm