

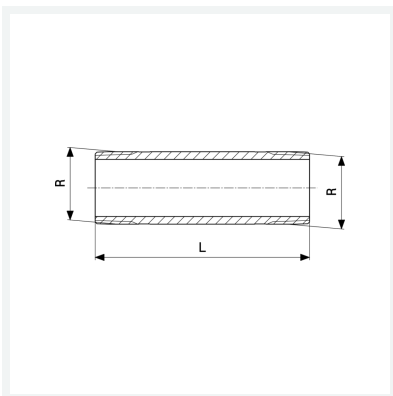

**Langnippel**  
- R-Gewinde  
**Modell 3530**

**Artikel 267 377**



## Eigenschaften

Länge	L	200
Außengewinde kegelig	R	½
Länge	L	200 mm
Gewicht	342,65 g	
Volumen	207,2 cm <sup>3</sup>	
Werkstoff	Rotguss oder Siliziumbronze	