

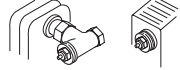

T6000 Series Thera-3

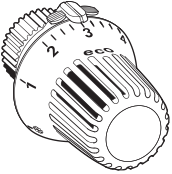

			0 - * - 5	* - 5		L
	T6001	•		•	M30x1,5	
	T6001W0	•	•		M30x1,5	
	T6001DA			•	RA-type	
	T6001DAW0		•		RA-type	
	T6001HZ			•	M28x1,5	
	T6001HZW0		•		M28x1,5	
	T6002				•	M30x1,5
T6002W0		•			M30x1,5	
	T600120	•		•	M30x1,5	2 m
	T600120W0	•	•		M30x1,5	2 m
	T600120DA			•	RA-type	2 m

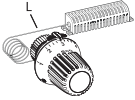

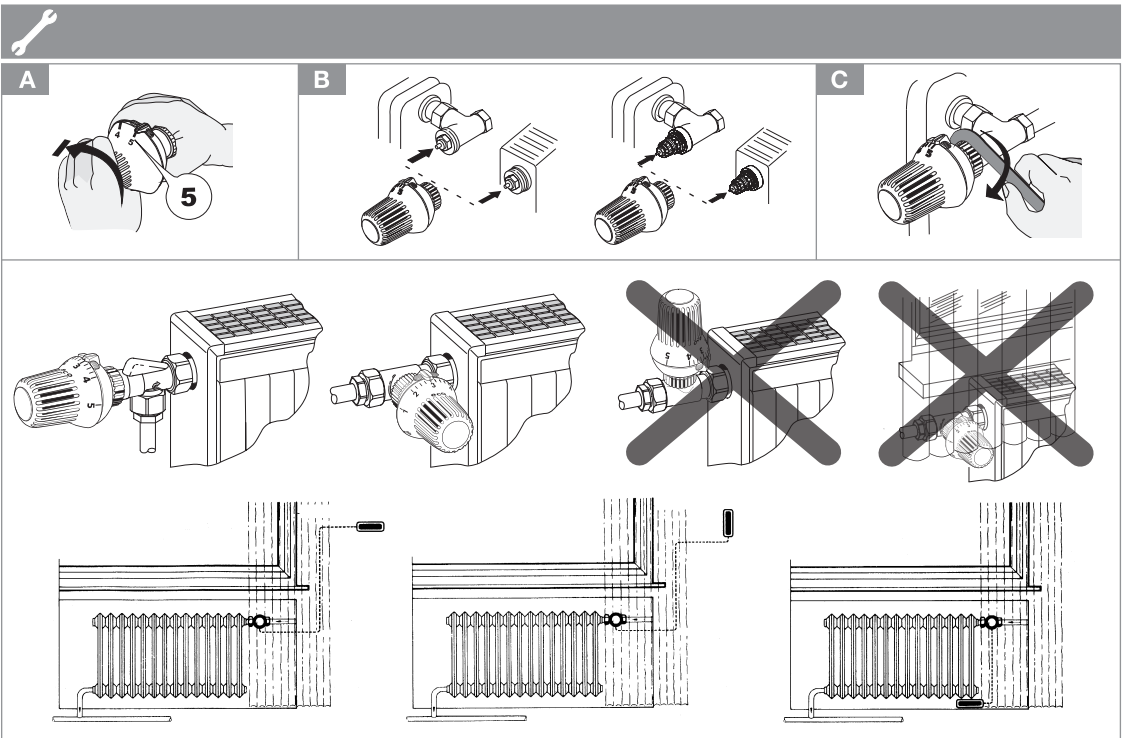

	0	*	1	2	3	4	5
°C	1	6	12	16	20	24	28
°F	34	43	54	61	68	75	82



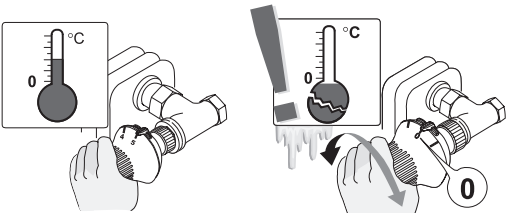









	*	1	2	3	4	5
°C	6	12	16	20	24	28
°F	43	54	61	68	75	82













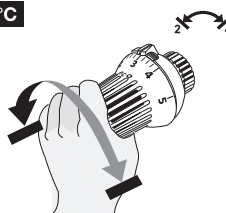
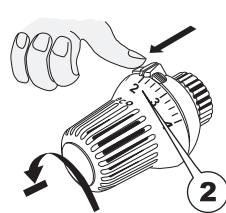
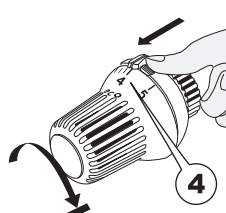
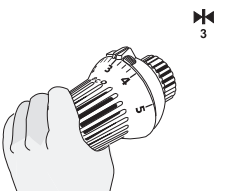
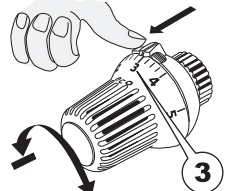
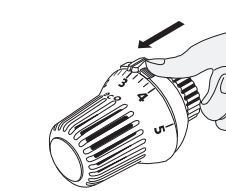







	24°C	
	20°C	
	18-20°C	
	18°C	
	17-18°C	
	16-17°C	



<p>16° - 24°C</p> 		
<p>20°C</p> 		



 <p>TA6900A001</p>	 <p>TA1010HZ01</p>	 <p>TA6000A001 TA6000D001</p>	 <p>TA1000B001</p>
 <p>TA1000A001 TA1000A002</p>	 <p>TA1010DA01</p>	 <p>VA8210A001</p>	

For more information
homecomfort.resideo.com/europe



Ademco 1 GmbH
 Hardhofweg 40
 74821 MOSBACH
 GERMANY
 Phone: +49 6261 810
 Fax: +49 6261 81309

Manufactured for and on behalf of the
 Pittway Sàrl, La Pièce 4, 1180 Rolle, Switzerland
 by its Authorised Representative Ademco 1 GmbH
 MU2H-2002GE25 R1119
 Subject to change
 © 2019 Pittway Sàrl. All rights reserved.
 This document contains proprietary information of
 Pittway Sàrl and its affiliated companies and is
 protected by copyright and other international
 laws. Reproduction or improper use without specific
 written authorisation of Pittway Sàrl is strictly
 forbidden. The Honeywell Home trademark is used
 under license from Honeywell International Inc.

