

Edition 400

31582740100 Waschtischunterbau

PRODUKT



ZEICHNUNG

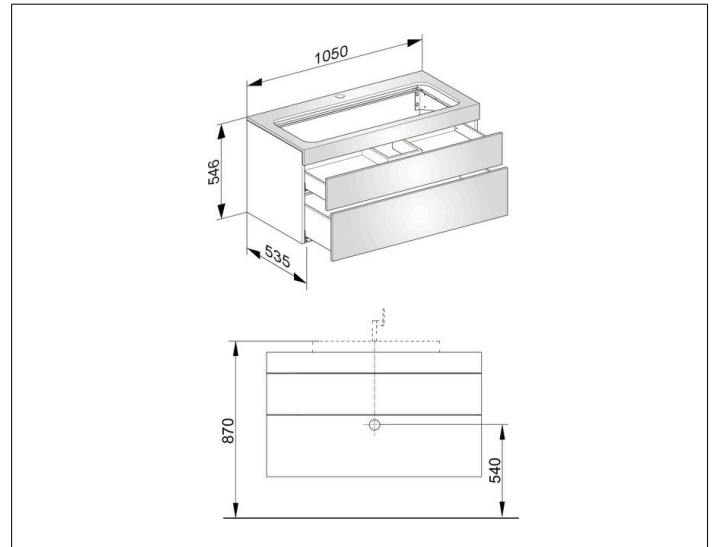

OBERFLÄCHE

weiß/Glas cashmere klar

ABMESSUNG

1050 x 546 x 535 mm