

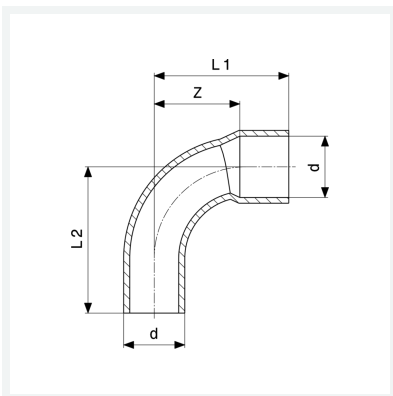

Bogen 90°
- Lötanschluss, Einsteckende
Modell 95001A

Artikel 100 827



Eigenschaften

Gütesicherung Cu	Cu	✓
Rohraußendurchmesser	d	28
Z-Maß	Z	34 mm
Länge 1	L1	53 mm
Länge 2	L2	55 mm
Gewicht	82 g	
Volumen	173,2 cm ³	
Werkstoff	Kupfer	