

Edition 400

31582390100 Waschtischunterbau

PRODUKT



ZEICHNUNG

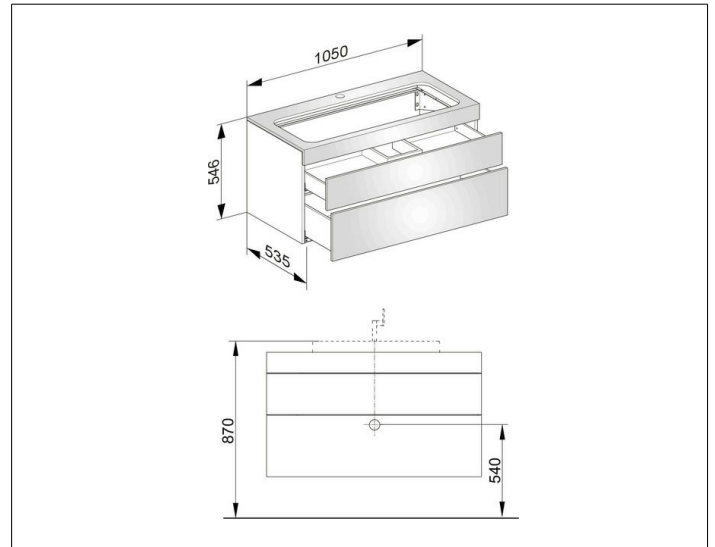

OBERFLÄCHE

anthrazit/anthrazit

ABMESSUNG

1050 x 546 x 535 mm