

X-Line
33295971000 Kristallspiegel

PRODUKT

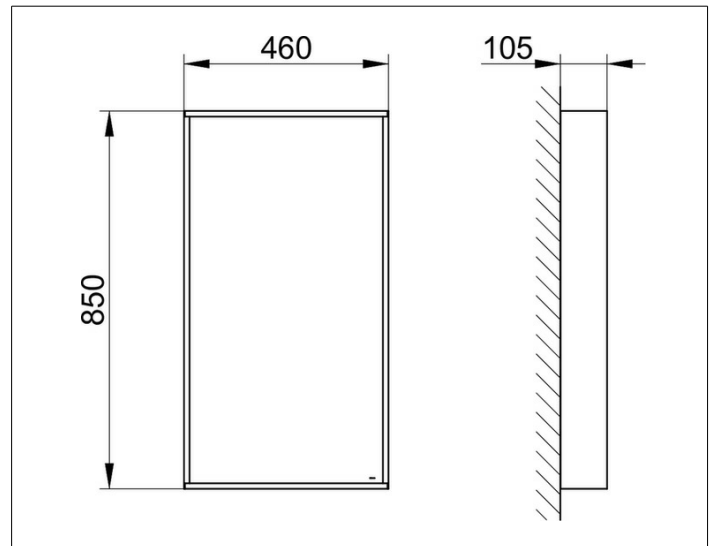

ZEICHNUNG



OBERFLÄCHE

vulkanit

ABMESSUNG

460 x 850 x 105 mm