

X-Line

3329718250 Lichtspiegel

PRODUKT

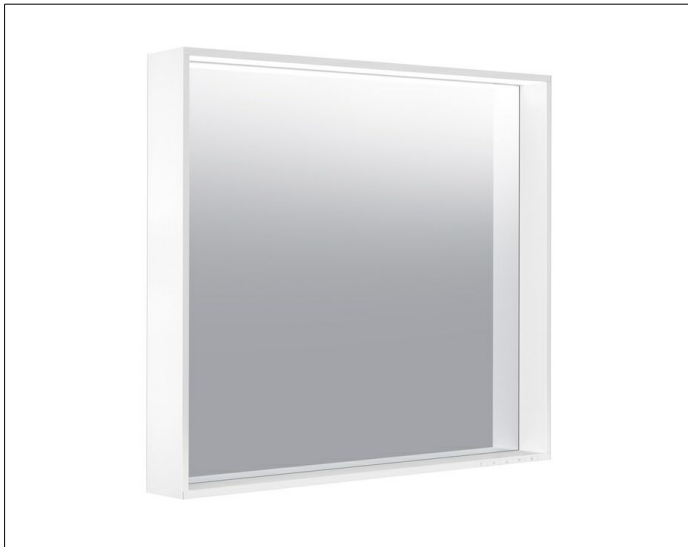

ZEICHNUNG

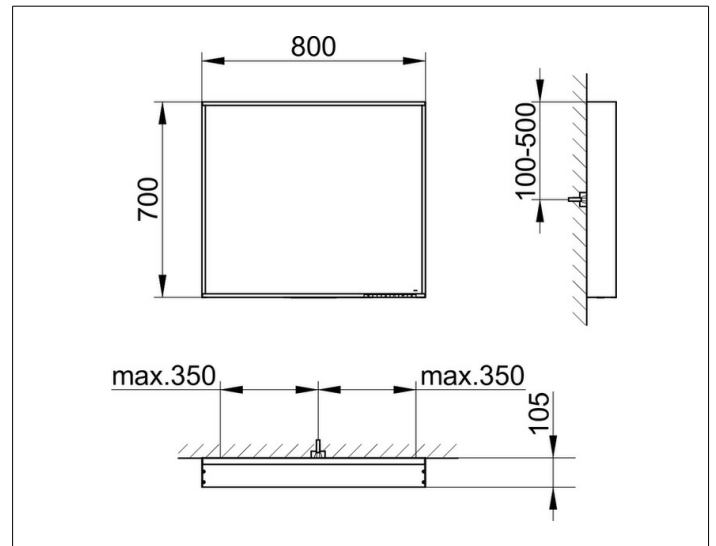

EEK: C , 33 kWh/1000h

OBERFLÄCHE

cashmere

ABMESSUNG

800 x 700 x 105 mm