

X-Line

33295301500 Kristallspiegel

PRODUKT



ZEICHNUNG

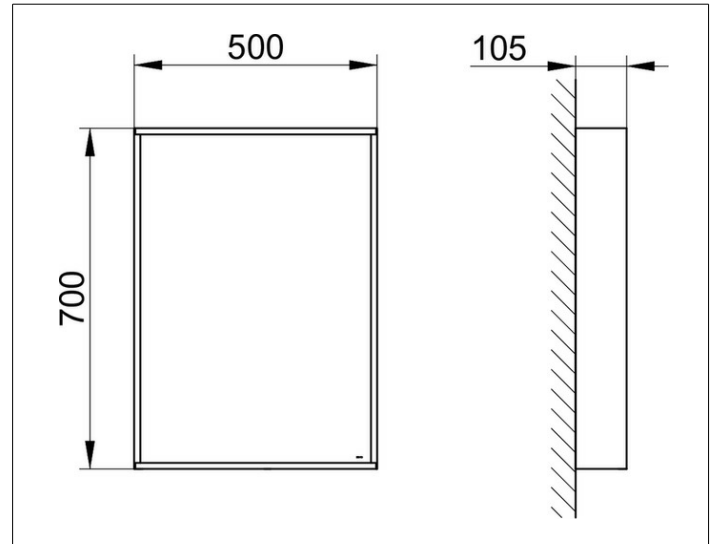

OBERFLÄCHE

weiß

ABMESSUNG

500 x 700 x 105 mm