

Edition 400

31582680100 Waschtischunterbau

PRODUKT



ZEICHNUNG

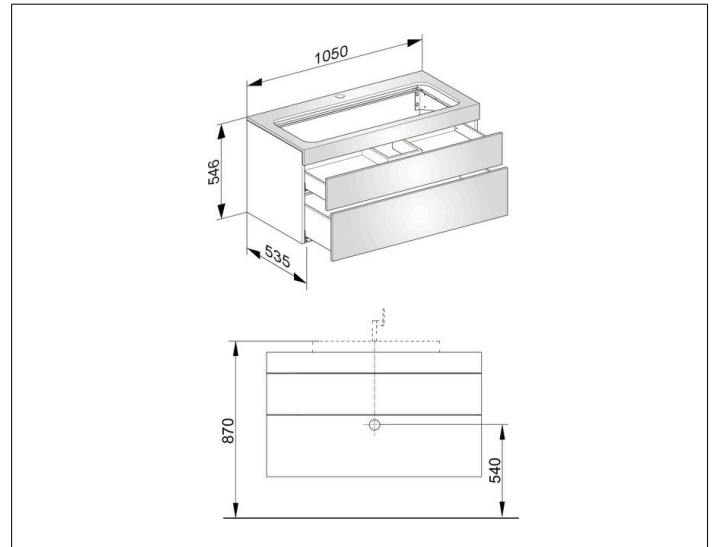

OBERFLÄCHE

Nussbaum/Nussbaum

ABMESSUNG

1050 x 546 x 535 mm