

# Betriebsanleitung

**CAVIUS** By  
 **AFRISO**



## Funk-Rauchwarnmelder

**ASD 10**  
**ASD 20**

---

Copyright 2021 AFRISO-EURO-INDEX GmbH. Alle Rechte vorbehalten.



EN 14604:2005+AC:2008  
DoP.: ASD 10/ASD 20

Version: 06.2021.0  
ID: 900.000.0801

Lindenstraße 20  
74363 Güglingen  
Telefon +49 7135 102-0  
Service +49 7135 102-211  
Telefax +49 7135 102-147  
info@afriso.com  
www.afriso.com

## 1 Über diese Betriebsanleitung

Diese Betriebsanleitung beschreibt den „Funk-Rauchwarnmelder ASD 10“ und den „Funk-Rauchwarnmelder ASD 20“ (im folgenden auch „Produkt“). Diese Betriebsanleitung ist Teil des Produkts.

- Sie dürfen das Produkt erst benutzen, wenn Sie die Betriebsanleitung vollständig gelesen und verstanden haben.
- Stellen Sie sicher, dass die Betriebsanleitung für alle Arbeiten an und mit dem Produkt jederzeit verfügbar ist.
- Geben Sie die Betriebsanleitung und alle zum Produkt gehörenden Unterlagen an alle Benutzer des Produkts weiter.
- Wenn Sie der Meinung sind, dass die Betriebsanleitung Fehler, Widersprüche oder Unklarheiten enthält, wenden Sie sich vor Benutzung des Produkts an den Hersteller.

Diese Betriebsanleitung ist urheberrechtlich geschützt und darf ausschließlich im rechtlich zulässigen Rahmen verwendet werden. Änderungen vorbehalten.

Für Schäden und Folgeschäden, die durch Nichtbeachtung dieser Betriebsanleitung sowie Nichtbeachten der am Einsatzort des Produkts geltenden Vorschriften, Bestimmungen und Normen entstehen, übernimmt der Hersteller keinerlei Haftung oder Gewährleistung.

## 2 Informationen zur Sicherheit

### 2.1 Warnhinweise und Gefahrenklassen

In dieser Betriebsanleitung finden Sie Warnhinweise, die auf potenzielle Gefahren und Risiken aufmerksam machen. Zusätzlich zu den Anweisungen in dieser Betriebsanleitung müssen Sie alle am Einsatzort des Produktes geltenden Bestimmungen, Normen und Sicherheitsvorschriften beachten. Stellen Sie vor Verwendung des Produktes sicher, dass Ihnen alle Bestimmungen, Normen und Sicherheitsvorschriften bekannt sind und dass sie befolgt werden.

Warnhinweise sind in dieser Betriebsanleitung mit Warnsymbolen und Signalwörtern gekennzeichnet. Abhängig von der Schwere einer Gefährdungssituation werden Warnhinweise in unterschiedliche Gefahrenklassen unterteilt.



## GEFAHR

GEFAHR macht auf eine unmittelbar gefährliche Situation aufmerksam, die bei Nichtbeachtung unweigerlich einen schweren oder tödlichen Unfall zur Folge hat.

---



## VORSICHT

VORSICHT macht auf eine möglicherweise gefährliche Situation aufmerksam, die bei Nichtbeachtung einen Unfall oder Sachschäden zur Folge haben kann.

---

## HINWEIS

HINWEIS macht auf eine möglicherweise gefährliche Situation aufmerksam, die bei Nichtbeachtung Sachschäden zur Folge haben kann.

---

Zusätzlich werden in dieser Betriebsanleitung folgende Symbole verwendet:



Dies ist das allgemeine Warnsymbol. Es weist auf die Gefahr von Verletzungen und Sachschäden hin. Befolgen Sie alle im Zusammenhang mit diesem Warnsymbol beschriebenen Hinweise, um Unfälle mit Todesfolge, Verletzungen und Sachschäden zu vermeiden.

## 2.2 Bestimmungsgemäße Verwendung

Das Produkt eignet sich ausschließlich zur Erkennung von Rauchentwicklung durch Feuer für den privaten Gebrauch. Der Sensorkopf Rauchwarnmelder ASD kann nur zusammen mit dem Funk-Montagesockel ASD 10 oder ASD 20 betrieben werden.

Eine andere Verwendung ist nicht bestimmungsgemäß und verursacht Gefahren.

Das Produkt darf nur in Innenräumen verwendet werden:

- Schlaf-, Wohn- und Arbeitsräume
- Kinderzimmer
- Lounges, Flure und Fluchtwege
- Campingfahrzeuge

Stellen Sie vor Verwendung des Produkts sicher, dass das Produkt für die von Ihnen vorgesehene Verwendung geeignet ist. Berücksichtigen Sie dabei mindestens folgendes:

- Alle am Einsatzort geltenden Bestimmungen, Normen und Sicherheitsvorschriften
- Alle für das Produkt spezifizierten Bedingungen und Daten
- Die Bedingungen der von Ihnen vorgesehenen Anwendung

Führen Sie darüber hinaus eine Risikobeurteilung in Bezug auf die konkrete, von Ihnen vorgesehene Anwendung nach einem anerkannten Verfahren durch und treffen Sie entsprechend dem Ergebnis alle erforderlichen Sicherheitsmaßnahmen. Berücksichtigen Sie dabei auch die möglichen Folgen eines Einbaus oder einer Integration des Produkts in ein System oder in eine Anlage.

Führen Sie bei der Verwendung des Produkts alle Arbeiten ausschließlich unter den in der Betriebsanleitung und auf dem Typenschild spezifizierten Bedingungen und innerhalb der spezifizierten technischen Daten und in Übereinstimmung mit allen am Einsatzort geltenden Bestimmungen, Normen und Sicherheitsvorschriften durch.

## 2.3 Vorhersehbare Fehlanwendung

Das Produkt darf insbesondere in folgenden Fällen und für folgende Zwecke nicht angewendet werden:

- Badezimmer, Duschräume, Küchen und andere Räume, in denen Rauch oder Dampf entstehen kann
- Bereiche, in denen Staub oder Dämpfe entstehen können (beispielsweise Garagen oder Werkstätten)
- Räume die höher als 6 m sind
- Giebelbereich, da sich hier im Brandfall rauchfreie Luft ansammeln kann
- In der Nähe von Feuerstätten und offenen Kaminen
- In der Nähe von Heizanlagen und Klimaanlage
- Explosionsgefährdete Umgebung
  - Bei Betrieb in explosionsgefährdeten Bereichen kann Funkenbildung zu Verpuffungen, Brand oder Explosionen führen
- Boote

## 2.4 Qualifikation des Personals

Arbeiten an und mit diesem Produkt dürfen nur von Personen vorgenommen werden, die den Inhalt dieser Betriebsanleitung und alle zum Produkt gehörenden Unterlagen kennen und verstehen.

## 2.5 Persönliche Schutzausrüstung

Verwenden Sie immer die erforderliche persönliche Schutzausrüstung. Berücksichtigen Sie bei Arbeiten an und mit dem Produkt auch, dass am Einsatzort Gefährdungen auftreten können, die nicht direkt vom Produkt ausgehen.

## 2.6 Veränderungen am Produkt

Führen Sie ausschließlich solche Arbeiten an und mit dem Produkt durch, die in dieser Betriebsanleitung beschrieben sind. Nehmen Sie keine Veränderungen vor, die in dieser Betriebsanleitung nicht beschrieben sind.

## 3 Transport und Lagerung

Das Produkt kann durch unsachgemäßen Transport und Lagerung beschädigt werden.

### HINWEIS

#### UNSACHGEMÄSSE HANDHABUNG

- Stellen Sie sicher, dass während des Transports und der Lagerung des Produkts die spezifizierten Umgebungsbedingungen eingehalten werden.
- Benutzen Sie für den Transport die Originalverpackung.
- Lagern Sie das Produkt nur in trockener, sauberer Umgebung.
- Stellen Sie sicher, dass das Produkt bei Transport und Lagerung stoßgeschützt ist.

**Nichtbeachtung dieser Anweisungen kann zu Sachschäden führen.**

---

## 4 Produktbeschreibung

### 4.1 Übersicht

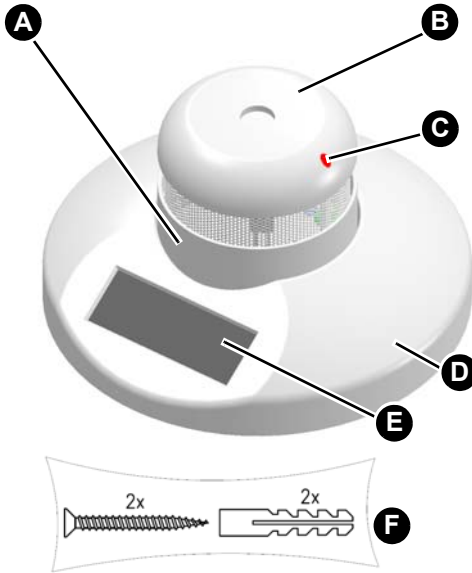

- A. Sensorkopf Rauchwarnmelder ASD
- B. Druckknopftaster (Testknopf)
- C. Rote LED
- D. Funk-Montagesockel ASD 10/ASD 20
- E. Solarzelle
- F. Montagezubehör

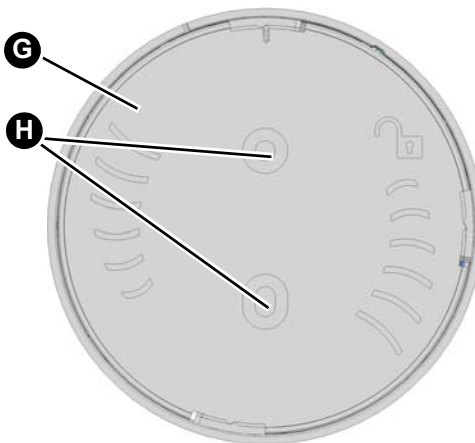

- G. Abdeckung/Halter
- H. Befestigungslöcher

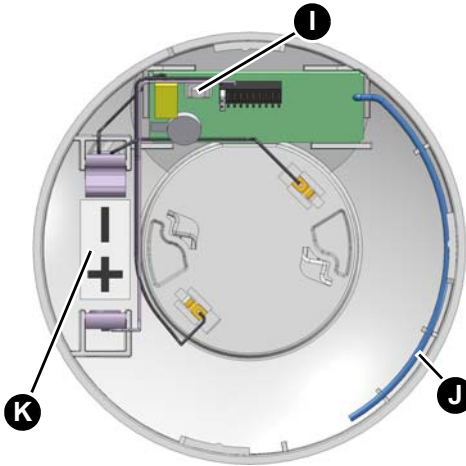

- I. LRN-Taste
- J. Antenne
- K. Batteriefach für optionale Lithium-Batterie (3,6 V ½ AA)

## 4.2 Abmessungen

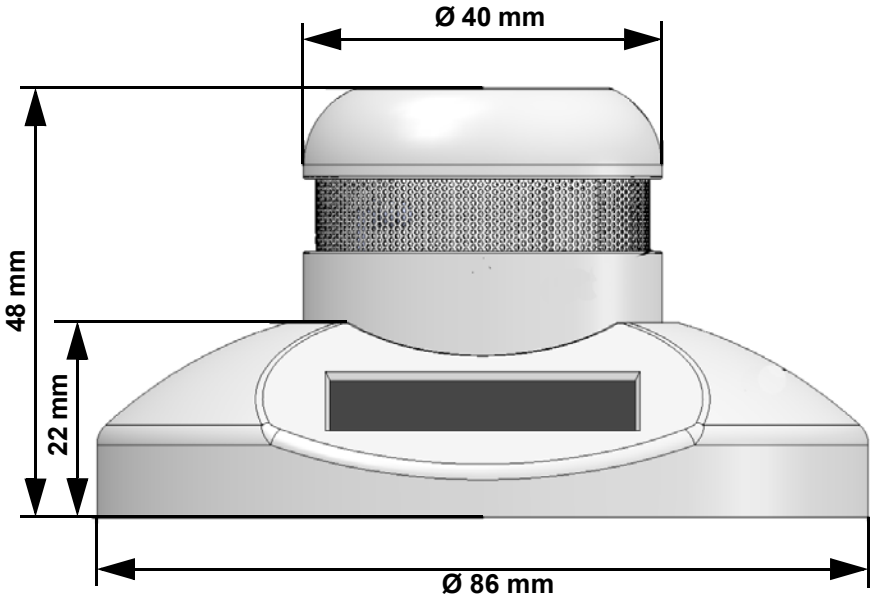



## 4.3 Funktion

Der Sensorkopf Rauchwarnmelder ASD kann nur zusammen mit dem Funk-Montagesockel ASD 10 oder ASD 20 betrieben werden. Eine Solarzelle erzeugt die nötige Energie. Der Sensorkopf Rauchwarnmelder ASD wird batteriebetrieben und hat eine Lebensdauer von etwa 10 Jahren. Eine schwache Batteriekapazität wird optisch und akustisch signalisiert.

Das Produkt erkennt die Entwicklung von Rauch- und Brandgas und warnt durch ein lautes, akustisches Signal (ca. 85 dB).

Über eine LED kann der Zustand geprüft werden:

- Normalbetrieb: LED blinkt alle 48 Sekunden
- Erhöhte Abtastrate: LED blinkt alle 2 Sekunden
- Alarm: LED blinkt alle 0,5 Sekunden

Über EnOcean®-Funk überträgt das Produkt ASD 10 folgende Informationen:

- Zustand Alarm/kein Alarm (zyklisch)
- Zustandsänderung (sofort)
- Umgebungstemperatur (zyklisch)

Über EnOcean®-Funk überträgt das Produkt ASD 20 folgende Informationen:

- Zustand Alarm/kein Alarm (zyklisch)
- Zustandsänderung (sofort)
- Zustand Batterie (zyklisch)

Jedes Produkt besitzt eine eindeutige Kennung. Beim Einsatz mehrerer Produkte kann der Empfänger diese durch die Kennung unterscheiden.

## 4.4 Zulassungsdokumente, Bescheinigungen, Erklärungen

Das Produkt entspricht:

- EMV-Richtlinie (2014/30/EU)
- Niederspannungsrichtlinie (2014/35/EU)
- Radio Equipment Directive, RED (2014/53/EU)
- RoHS-Richtlinie (2011/65/EU)
- Ökodesign-Richtlinie (2009/125/EG)

## 4.5 Technische Daten

### 4.5.1 Funk-Montagesockel ASD 10/ASD 20

Parameter	Wert
<b>Allgemeine Daten</b>	
Abmessungen (Ø B x H)	86 x 22 mm
Gewicht	38 g
Werkstoff Gehäuse	PC/ABS
Farbe	Weiß, ähnlich RAL 9003
Temperaturmessbereich	0 ... 40 °C, ±1 K
<b>Umgebungsbedingungen</b>	
Umgebungstemperatur Betrieb	0 ... 40 °C
Umgebungstemperatur Lagerung	-20 ... 60 °C
Maximale Luftfeuchtigkeit	90 % (nicht kondensierend)
<b>Spannungsversorgung</b>	
Über Solarzelle	Energy harvesting
Über Lithium-Batterie (optional)	DC 3,6 V ½ AA
<b>Elektrische Daten</b>	
Schutzklasse (EN 60730-1; SELV)	III
Schutzart	IP 30
<b>EnOcean®-Funk - ASD 10</b>	
Frequenz	868,3 MHz
Sendeleistung	Max. 10 mW
Reichweite	Siehe Kapitel "Informationen zu EnOcean®-Funk"
EnOcean Equipment Profile (EEP)	A5-30-03

Parameter	Wert
<b>EnOcean®-Funk - ASD 20</b>	
Frequenz	868,3 MHz
Sendeleistung	Max. 10 mW
Reichweite	Siehe Kapitel "Informationen zu EnOcean®-Funk"
EnOcean Equipment Profile (EEP)	F6-05-02

## 4.5.2 Sensorkopf Rauchwarnmelder ASD

Parameter	Wert
Abmessungen (Ø B x H)	40 x 43 mm
Rauchwarnmelder Typ	Optisch
Einsatzbereich	Private Wohnungen/Häuser
Interne Batterie (nicht austauschbar)	Lithium, 3 V, 1,6 Ah
Lebensdauer	10 Jahre bei normalem Gebrauch (1 Test pro Woche)
Alarm Schalldruckpegel	85 dB
<b>Umgebungsbedingungen</b>	
Umgebungstemperatur Betrieb	4 ... 38 °C
Umgebungstemperatur Lagerung	-20 ... 60 °C
Maximale Luftfeuchtigkeit	90 % (nicht kondensierend)

## 5 Montage

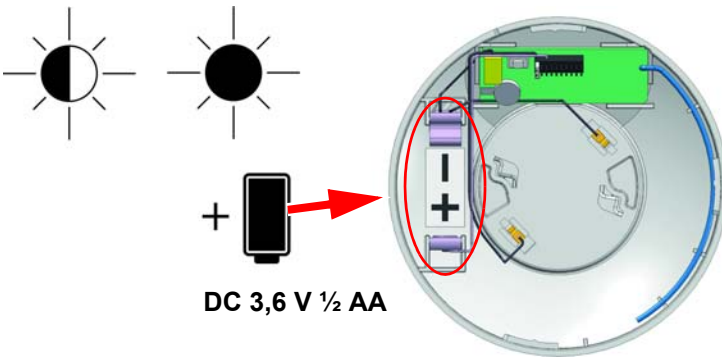
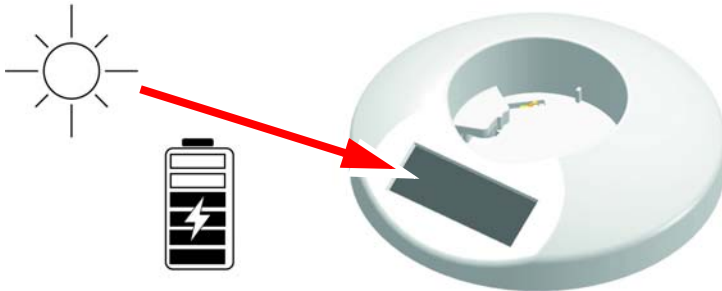
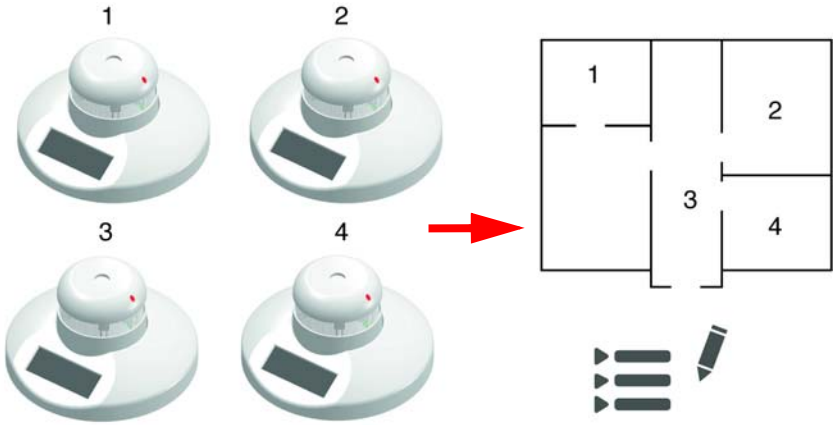

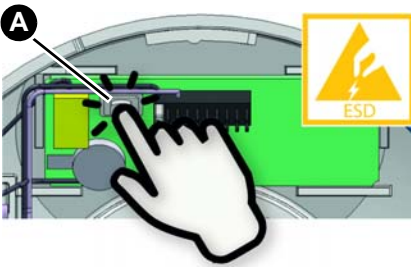

A. LRN-Taste



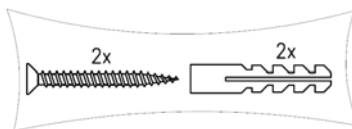
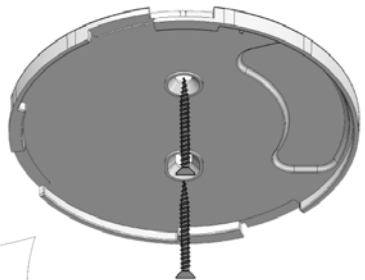
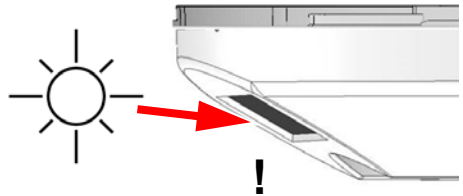
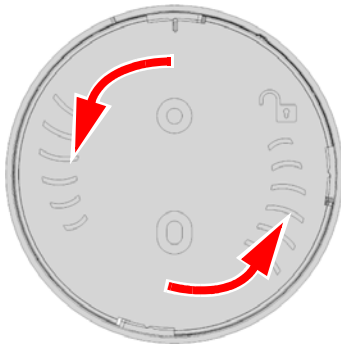
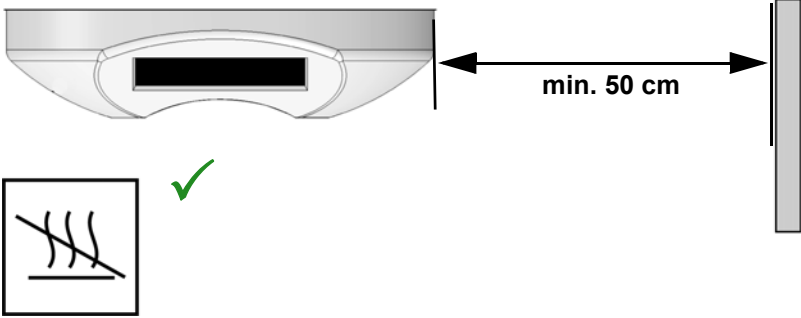

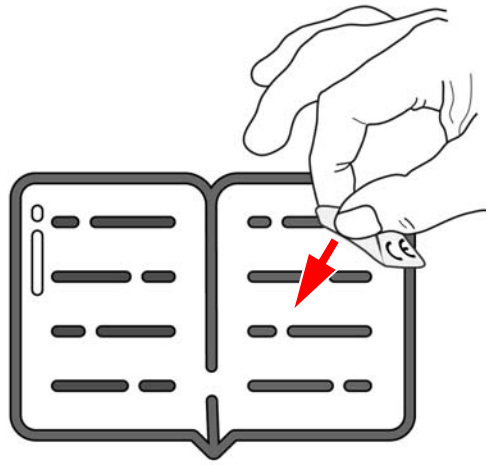
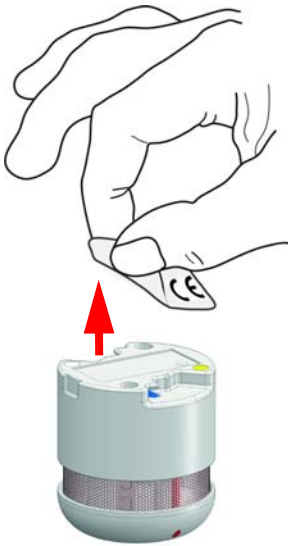
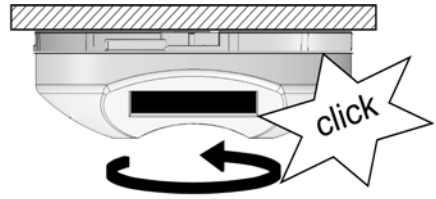
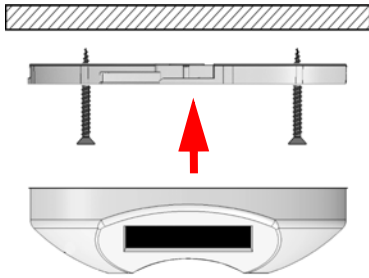

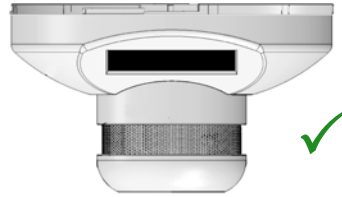
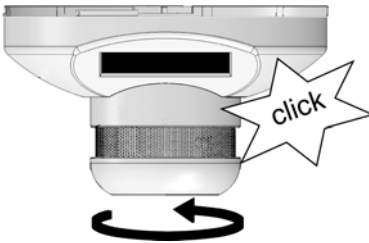
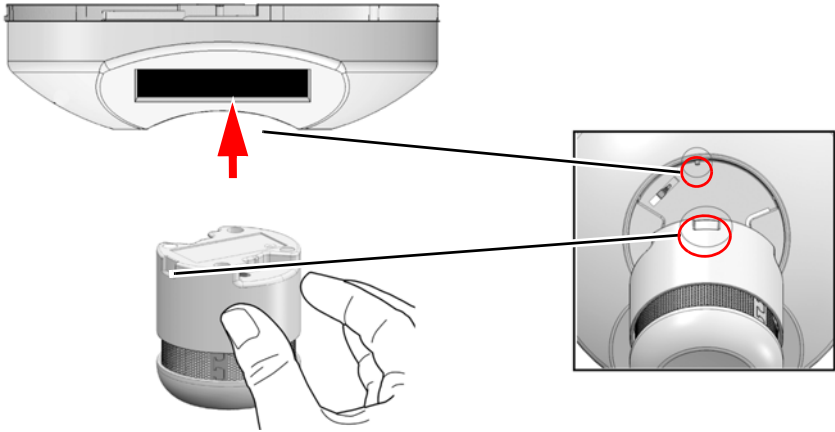



## 6 Inbetriebnahme

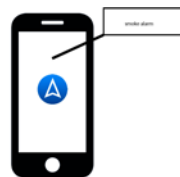
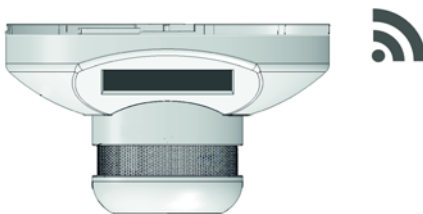
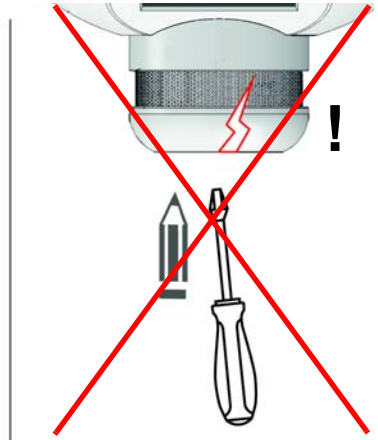
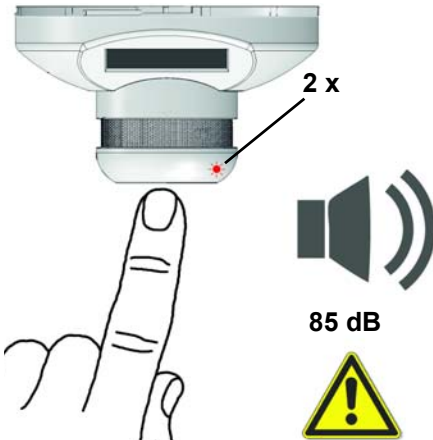

## 7 Alarm

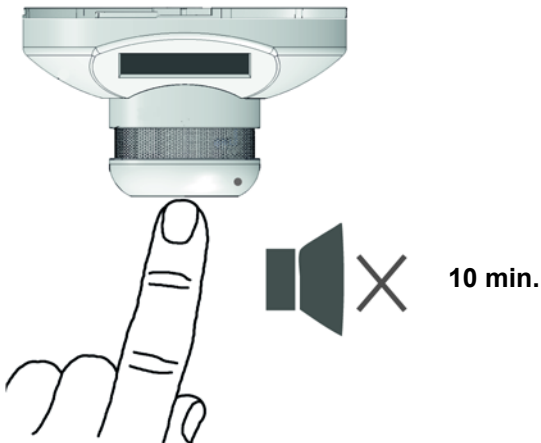
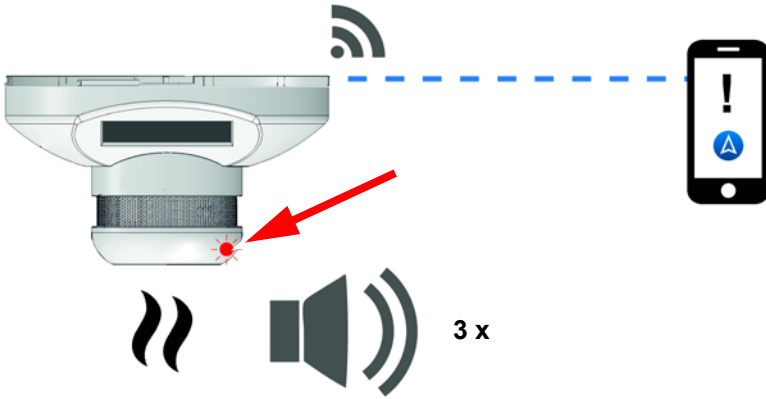

## 8 Wartung und Reinigung



≥ 3 Monate



≥ 3 Monate



**Sensorkopf tauschen**

Siehe "Montage"

## 9 Störungsbeseitigung

Störungen, die nicht durch die im Kapitel beschriebenen Maßnahmen beseitigt werden können, dürfen nur durch den Hersteller oder Fachkräften behoben werden.

Problem	Mögliche Ursache	Fehlerbehebung
Kein Funksignal	Der Funk-Montagesockel ASD 10/ASD 20 ist nicht aufgeladen	Legen Sie den Funk-Montagesockel ASD 10/ASD 20 für ungefähr 10 Minuten in die Sonne.  Legen Sie eine Lithium-Batterie in den Funk-Montagesockel ASD 10/ASD 20 ein.
	Der Funk-Montagesockel ASD 10/ASD 20 ist nicht richtig in das AFRI-SOhome Gateway eingelernt	Lernen Sie den Funk-Montagesockel ASD 10/ASD 20 erneut ein (siehe Kapitel "Montage").
	Umfeld des Funk-Montagesockels ASD 10/ASD 20 hat sich geändert (Störung des Funkfeldes)	Prüfen Sie das Umfeld des Funk-Montagesockels ASD 10/ASD 20 auf Veränderungen/Störungen (Metallschränke, Möbel/Wände wurden versetzt).
Ein kurzer Ton ertönt und die rote LED blinkt alle 48 Sekunden am Sensorkopf Rauchwarnmelder ASD	Batterie ist leer	Tauschen Sie den Sensorkopf Rauchwarnmelder ASD aus. Ab Beginn dieses Tons kann der Rauchwarnmelder ASD noch 30 Tage oder bei Alarm 4 Minuten betrieben werden.

<b>Problem</b>	<b>Mögliche Ursache</b>	<b>Fehlerbehebung</b>
Energiespeicher des Funk-Montagesockels ASD 10/ASD 20 ist entladen	Keine ausreichende Beleuchtung	Sorgen Sie für eine Lichtquelle.
	Lithium-Batterie entladen.	Setzen Sie eine (neue) Lithium-Batterie ein (siehe "Produktbeschreibung").
Reichweiteneinschränkung der Funksignale	Metallgegenstände oder Materialien mit Metallbestandteilen in der Nähe	Halten Sie einen Mindestabstand von 50 cm zu Gegenständen oder Wänden ein.
Sonstige Störungen	-	Bitte wenden Sie sich an die AFRISO-Service Hotline

## 10 Außerbetriebnahme und Entsorgung

Entsorgen Sie das Produkt nach den geltenden Bestimmungen, Normen und Sicherheitsvorschriften.

### 10.1 Informationen zur Entsorgung

Elektronikteile dürfen nicht mit dem Hausmüll entsorgt werden.



1. Demontieren Sie das Produkt (siehe Kapitel "Montage" in umgekehrter Reihenfolge).
2. Entsorgen Sie das Produkt und optionale Batterien getrennt.

### 10.2 Informationen zum Umgang mit Batterien



## GEFAHR

### EXPLOSION, BRAND ODER GIFTIGE STOFFE

Bei unsachgemäßer Handhabung können von Lithium-Batterien Gefahren ausgehen

- Beachten Sie die Hinweise zum Umgang mit Lithium-Batterien in diesem Kapitel.

**Nichtbeachtung dieser Anweisungen führt zu Tod oder schweren Verletzungen.**

- Verwenden Sie nur den in dieser Anleitung angegebenen Batterie-Typ.
- Setzen Sie Batterien keinen mechanischen Belastungen aus.
- Werfen Sie Batterien niemals ins Feuer.
- Halten Sie die angegebenen Umgebungsbedingungen ("Technische Daten") ein.
- Verwenden Sie keine beschädigten, verformten oder heißen Batterien.
- Achten Sie darauf, dass Batterien nicht in die Hände von Kindern gelangen.

## 11 Rücksendung

Vor einer Rücksendung Ihres Produkts müssen Sie sich mit uns in Verbindung setzen (service@afriso.de).

## 12 Gewährleistung

Informationen zur Gewährleistung finden Sie in unseren Allgemeinen Geschäftsbedingungen im Internet unter [www.afriso.com](http://www.afriso.com) oder in Ihrem Kaufvertrag.

## 13 Ersatzteile und Zubehör



### HINWEIS

#### BESCHÄDIGUNG DURCH UNGEEIGNETE TEILE

- Verwenden Sie nur Original Ersatz- und Zubehörteile des Herstellers.

**Nichtbeachtung dieser Anweisung kann zu Sachschäden führen.**

#### Produkt

Artikelbezeichnung	Art.-Nr.	Abbildung
Funk-Rauchwarnmelder ASD 10 Funk-Rauchwarnmelder ASD 20	61245 61249	
Funk-Montagesockel ASD 10 Funk-Montagesockel ASD 20	61247 61253	
Sensorkopf Rauchwarnmelder ASD	61246	

## 14 Informationen zu EnOcean®-Funk

### 14.1 Reichweiten des EnOcean®-Funks

Weiterführende Informationen zur Reichweitenplanung mit EnOcean® finden Sie auf [www.enocean.com](http://www.enocean.com).

### 14.2 Weiterführende Informationen zu EnOcean®-Funksystemen

Weiterführende Informationen zu Planung, Installation und Betrieb von EnOcean®-Funksystemen finden Sie auf [www.enocean.com](http://www.enocean.com).

- Funkstandard
- Funktechnologie
- AN001
- AN102
- AN103
- AN201

### 14.3 Möglichkeiten der EnOcean®-Technologie

Unterlagen über EnOcean®-Technologien finden Sie im Internet unter [www.afrisohome.de](http://www.afrisohome.de).

Auf unserem YouTube-Channel finden Sie eine Reihe von Videos zu AFRISO-Produkten.



## 15 Anhang

### 15.1 Nachweis für Ihre jährliche Überprüfung

Anbringungsort (Beispiel: Flur EG)	Datum			

## 15.2 EU-Konformitätserklärung

	
<b>Technik für Umweltschutz</b> Messen. Regeln. Überwachen.	
<b>EU - Konformitätserklärung</b> EU Declaration of Conformity / Déclaration EU de conformité / Declaración de conformidad CE / Declaração de conformidade CE / Deklaracja zgodności UE	
	<b>Formblatt FB 27 - 03</b>
Name und Anschrift des Herstellers: <u>AFRISO-EURO-INDEX GmbH, Lindenstraße 20, 74363 Güglingen</u> <i>Manufacturer / Fabricant / Fabricante / Nome e endereço do fabricante / Producent:</i>	
Erzeugnis: <u>Funk-Montagesockel für Rauchwarnmelder und Hitzemelder</u> <i>Product / Produit / Producto / Produto / Produkt:</i>	
Typenbezeichnung: <u>ASD 10, ASD 20, AHD 10, AHD 20</u> <i>Type / Type / Tipo / Tipo / Typ:</i>	
Betriebsdaten: <u>Solar 3V oder Batterie 3.6V</u> <i>Techn. Details / Caractéristiques / Características / Detalhes técnicos / Dane techniczne:</i>	
Das bezeichnete Erzeugnis stimmt mit den Vorschriften folgender Europäischer Richtlinien überein: <i>The above mentioned product meets the requirements of the following European Directives:</i> <i>Le produit mentionné est conforme aux prescriptions des Directives Européennes suivantes:</i> <i>El producto indicado cumple con las prescripciones de las Directivas Europeas siguientes:</i> <i>O produto indicado cumpre com as prescrições das seguintes Diretivas Europeias:</i> <i>Wymieniony wyżej produkt spełnia wymagania następujących Dyrektyw Europejskich:</i>	
<b>Elektromagnetische Verträglichkeit (2014/30/EU)</b> <i>Directive Electromagnetic Compatibility / Directive compatibilité électromagnétique / Directiva compatibilidad electromagnética / Diretiva sobre compatibilidade eletromagnética / Dyrektywa kompatybilności elektromagnetycznej</i> <u>EN 301489-1;V2.2.0; EN 301489-3;V2.1.1</u>	
<b>Niederspannungsrichtlinie (2014/35/EU)</b> <i>Low Voltage Directive / Directive basse tension / Directiva baja tensión / Diretiva sobre baixa tensão / Dyrektywa niskonapięciowa</i> <u>DIN EN 62368-1:2014/+AC:2017</u>	
<b>Radio Equipment Directive, RED (2014/53/EU)</b> <i>RED Directive / Directive RED / Directiva RED / Diretiva RED / Dyrektywa radiowa</i> <u>EN 300220-2;V3.1.1.; EN 62479:2010</u>	
<b>RoHS-Richtlinie (2011/65/EU)</b> <i>RoHS Directive / Directive RoHS / Directiva RoHS / Diretiva RoHS / Dyrektywa RoHS</i> <u>EN IEC 63000:2018</u>	
Unterzeichner: <i>Signed / Signataire / Firmante / Assinado por / Podpisal:</i>	<u>Dr. Späth, Geschäftsführer Technik</u> <i>Technical Director / Diretor Técnico / Dyrektor Techniczny</i>
<u>9.2.2021</u> Datum / Date / Fecha / Data	 AFRISO-EURO-INDEX GmbH Lindenstraße 20 • 74363 Güglingen Tel. +49 7145 102-0 • www.afriso.de Unterschrift / Signature / Firma / Assinatura / Podpis
Version: 3 Index: 2	AFRISO-EURO-INDEX GmbH D-74363 Güglingen
Seite 1 von 1	

## 15.3 Testbericht CNPP



Prévention et maîtrise des risques

GRUPE CNPP  
 LPMES / LEI  
 LABORATOIRE ELECTRONIQUE INCENDIE  
 Route de la chapelle Réanville  
 CD 64 – CS22265  
 F27950 SAINT-MARCEL  
 Téléphone : +33 (0)2 32 53 64 49  
 Télécopie : +33 (0)2 32 53 64 96

## AVIS TECHNIQUE / TECHNICAL ASSESSMENT N° FE 21 00 07

DEMANDE PAR : **CNPP Cert**  
 REQUIRED BY : Route de la chapelle Réanville  
 CD 64 – CS22265 F27950 – SAINT MARCEL

DOSSIER ENREGISTRE SOUS LE N° : **FL2021-27-A201**  
 DOSSIER REGISTRED UNDER THE N° :

DENOMINATION TECHNIQUE : **Dispositif d'Alarme de Fumée**  
 TECHNICAL DESIGNATION : **Smoke alarm device**

REFERENCE COMMERCIALE : **ASD10 / ASD20**  
 COMMERCIAL REFERENCE :

MARQUE COMMERCIALE : **CAVIUS**  
 COMMERCIAL MARK :

CONSTRUCTEUR : **CAVIUS APS**  
 MANUFACTURER :

**DESCRIPTION DES EVOLUTIONS DECLAREES PAR LE CONSTRUCTEUR (voir § I)**  
 DESCRIPTION OF THE EVOLUTIONS DECLARED BY THE MANUFACTURER (see § I)

**EXAMEN****EXAMINATION**

- Conforme à la description et aux plans du Constructeur spécifiés dans la liste du rapport d'essais N° :  
 The product complies with the Manufacturer's description and drawing plans specified in the tests report N°:  
**FE 17 00 01 B**

**CONCLUSION****CONCLUSION**

Suite à l'analyse des évolutions déclarées par le constructeur mentionnées au § I, le produit identifié ci-dessus, satisfait aux exigences de l'annexe ZA de la norme EN 14604, (2005)+AC(2008).  
 Following the analysis of the evolutions declared by the manufacturer mentioned in §I the product identified above fulfills the requirements of the annex ZA of the EN 14604 (2005)+AC(2008) standard.

**AVIS TECHNIQUE ETABLI LE : 27 mai 2021**  
 DATE OF TECHNICAL ASSESSMENT



Essais effectués dans le cadre d'une demande de certificat de constance des performances selon le Règlement (UE) 305/2011 – Règlement Produit de Construction  
 Tests carried out in view of delivery of a certificate of constancy of performance according to the Regulation (EU) 305/2011 - Construction Product Regulation

Trame AT FE – EN 14604 – Version 6

Ce document atteste uniquement des caractéristiques de l'échantillon soumis aux essais ou à l'examen du laboratoire et ne préjuge pas des caractéristiques de produits similaires. Il ne constitue donc pas une certification de produit au sens de l'article L115-27 du code de la consommation, ni un agrément de qualité nature que ce soit. La reproduction de ce document n'est autorisée, sauf approbation préalable du CNPP, que sous sa forme intégrale. Le CNPP décline toute responsabilité en cas de reproduction ou de publication non conforme. Le CNPP se réserve le droit d'utiliser les enseignements qui résultent du présent document pour les inclure dans des travaux de synthèse ou d'intérêt général pouvant être publiés par ses soins.  
 This document gives evidence only of characteristics of the sample subjected to the tests carried out or scrutinized by the laboratory and does not prejudge characteristics of similar products. It does not thus constitute a certification of products in the sense of the article L115-27 of the code of the consumption, or an approved reviewer release it is. The reproduction of this document is not authorized, except preliminary approval of CNPP, only under its complete form. CNPP declines any responsibility in case of reproduction or not corresponding publication. CNPP reserves the right to use the information which result from the present document to include them in works of synthesis or general interest, the envisaged works which can be published by its case.

CNPP Entreprise SARL, au capital de 8 500 000 € • SIRET 34290125300050 - N° TVA FR 50342901253 - Code NAF 8559A • RC Evreux 1987900299  
 Siège Social : CS 22265 - F 27950 SAINT-MARCEL • N° formateur 23270036727 [www.cnpp.com](http://www.cnpp.com)

**I - DESCRIPTION DES EVOLUTIONS DECLAREES PAR LE CONSTRUCTEUR**  
*DESCRIPTION OF THE EVOLUTIONS DECLARED BY THE MANUFACTURER*

- Création des variantes du dispositif d'alarme de fumée :  
*Creation of variants of smoke alarm device:*  
**2301-001**

Celles-ci ne diffèrent que par les points suivants :  
*This one differs only by the following points:*

Référence / Reference: ASD10

- Transmission des informations suivantes par liaison radio « EnOcean » :
  - Etat alarme/Pas alarme (cyclique)
  - Température ambiante(cyclique)
  - Etat de transition (immédiat)
- *Transmit the following informations via « EnOcean » wireless :*
  - *State alarm/no alarm (cyclically)*
  - *Ambient temperature (cyclically)*
  - *State transition (immediately)*

Référence / Reference: ASD20



- Transmission des informations suivantes par liaison radio « EnOcean » :
  - Etat alarme/Pas alarme (cyclique)
  - Etat de la batterie (cyclique)
  - Etat de transition (immédiat)
- *Transmit the following informations via « EnOcean » wireless :*
  - *State alarm/no alarm (cyclically)*
  - *Battery state (cyclically)*
  - *State transition (immediately)*

Les résultats sont extrapolés du rapport d'essais N°:  
*The results are extrapolated from the tests report N°:*  
**FE 17 00 01 B (19/04/2021)**

Essais effectués dans le cadre d'une demande de certificat de constance des performances  
selon le Règlement (UE) 305/2011 – Règlement Produit de Construction  
*Tests carried out in view of delivery of a certificate of constancy of performance according  
to the Regulation (EU) 305/2011 - Construction Product Regulation*

Trame AT FE – EN 14604 – Version 6

## 15.4 CNPP Zertifikat

<b>CERTIFICAT DE CONSTANCE DES PERFORMANCES</b>		
<b>1116-CPR-131-1</b>		
<i>Conformément au règlement (UE) N°305/2011 du 09/03/2011 établissant les conditions harmonisées de commercialisation pour les produits de construction (Règlement Produits de Construction – RPC), il a été établi que les produits de construction désignés ci-dessous :</i>		
<b>ASD10 / ASD20 – AFRISO</b> <b>(Dispositif d’alarme de fumée)</b>		
<b>Source principale d’alimentation :</b>	<b>Interne au dispositif par pile lithium 3V (10 ans)</b>	
	<b>DURACELL ULTRA 123 - 1500 mAh</b> <b>HUIJIBELI CR123A - 1600 mAh</b> <b>PANASONIC CR123A - 1400 mAh</b>	
<b>Type de montage :</b>	<b>Mur, Plafond</b>	
<b>Liaison radio (autre que DAF-DAF) :</b>	<b>Oui</b>	
<b>Options avec exigences :</b>	<b>Indicateur d’alarme individuelle :</b> <b>Raccordement à des dispositifs auxiliaires externes :</b> <b>Dispositif d’alarme de fumée interconnectable :</b> <b>Dispositif de neutralisation d’alarme :</b> <b>D.A.F. destiné aux véhicules de type camping-cars :</b>	<b>Oui</b> <b>Oui</b> <b>Non</b> <b>Oui</b> <b>Oui</b>
<i>mis sur le marché par</i>		
<b>AFRISO-EURO-INDEX GmbH</b> Lindenstraße 20 – 74363 Güglingen – ALLEMAGNE		
<i>et produits dans l’unité de fabrication</i>		
<b>BAO JIE Electronic</b> 101, 201, 301, 401, 501 No. 12 Dongcai Industrial Zone, Gushu Community Xixiang Street – BAO AN District – SHENZHEN – CHINE		
<i>font l’objet par le fabricant d’un contrôle de production en usine (CPU) et d’essais sur des échantillons prélevés dans l’unité de fabrication selon un plan d’essais pré-établi,</i>		
<i>En sa qualité d’organisme certificateur notifié, CNPP Cert. a réalisé les essais de type initiaux pour les caractéristiques concernées du produit ainsi que l’inspection initiale de l’usine et du CPU. Il exerce la surveillance continue du CPU (évaluation et acceptation).</i>		
<b>Ce certificat garantit que toutes les dispositions concernant l’évaluation et la vérification de la constance des performances suivant le système 1 et les caractéristiques décrites en annexe ZA des normes EN 14604 : 2005/AC : 2008 ont été appliquées et que les produits satisfont aux exigences requises.</b>		
<b>Ce certificat, délivré initialement le 31/05/2021, demeure valide tant que les conditions fixées dans les spécifications techniques harmonisées citées en référence ou les conditions de production ou le CPU lui-même n’ont pas été modifiées de façon significative.</b>		
Le 31/05/2021 <b>Amaury LEQUETTE</b> Directeur CNPP Cert.		
	<b>CNPP Cert. organisme certificateur (NB 1116)</b> reconnu par les professionnels de la sécurité et de l’assurance Route de la Chapelle Réanville - CD 64 - CS 22265 - F 27950 LA CHAPELLE-LONGUEVILLE Tél. : +33 (0)2 32 53 63 63 - E.mail : certification@cnpp.com - www.cnpp.com	

## CERTIFICATE OF CONSTANCY OF PERFORMANCE

**1116-CPR-131-1**

*In compliance with Regulation [EU] N°305/2011 of 09/03/2011 laying down harmonised conditions for the marketing of construction products (Construction Products Regulation – CPR), it has been stated that the construction products below:*

### **ASD10 / ASD20 – AFRISO (Smoke alarm device)**

<b>Normal power source:</b>	<b>Internal to the device by lithium battery of 3V (10 years)</b>	
	DURACELL ULTRA 123 - 1500 mAh HUIDERUI CR123A - 1600 mAh PANASONIC CR123A - 1400 mAh	
<b>Type of mounting:</b>	Wall, Ceiling	
<b>Radio link (other than SAD-SAD):</b>	Yes	
<b>Options with requirements:</b>	<b>Individual alarm indicator:</b>	Yes
	<b>Connection of external ancillary devices:</b>	Yes
	<b>Inter-connectable smoke alarm device:</b>	No
	<b>Alarm silence facility:</b>	Yes
	<b>Smoke alarm device for leisure accommodation vehicles:</b>	Yes

*placed on the market by*

**AFRISO-EURO-INDEX GmbH**  
Lindenstraße 20 – 74363 Güglingen – GERMANY

*and produced in the factory*

**BAO JIE Electronic**  
101, 201, 301, 401, 501 No. 12 Dongcai Industrial Zone, Gushu Community Xixiang Street –  
BAO AN District – SHENZHEN – CHINA

*are submitted by the manufacturer to a factory production control (FPC) and to further testing of samples taken at the factory in accordance with a prescribes test plan,*

*The approved body, CNPP Cert., has performed the initial type-testing for the relevant characteristics of the product, the initial inspection of the factory and of the FPC and performs the continuous surveillance, assessment and approval of the FPC.*

**This certificate attests that all provisions concerning the assessment and verification of constancy of performance according to system 1 and the characteristics described in ZA annex of the standards EN 14604 : 2005/AC : 2008 were applied and that the product fulfills all prescribed requirements.**

*This certificate was first issued on 31/05/2021 and remains valid as long as the conditions laid down in the harmonised technical specification in reference or the manufacturing conditions in the factory or the FPC itself are not modified significantly.*

On 31/05/2021

**Amaury LEQUETTE**  
Manager of CNPP Cert.



**CNPP Cert.** certification body (NB 1116)  
recognized by the security and insurance professionals  
Route de la Chapelle Rianville - CD 64 - CS 22265 - F 27950 LA CHAPELLE-LONGUEVILLE  
Tel. : +33 (0)2 32 53 63 63 - E.mail : certification@cnpp.com - www.cnpp.com



# Operating instructions **CAVIUS**<sup>By</sup> **AFRISO**



## Wireless smoke alarm

**ASD 10**  
**ASD 20**

---

Copyright 2021 AFRISO-EURO-INDEX GmbH. All rights reserved.



EN 14604:2005+AC:2008  
DoP.: ASD 10/ASD 20

Version: 06.2021.0  
ID: 900.000.0801

Lindenstraße 20  
74363 Güglingen  
Telephone +49 7135 102-0  
Service +49 7135 102-211  
Telefax +49 7135 102-147  
info@afriso.com  
www.afriso.com

## 1 About these operating instructions

These operating instructions describe the "wireless smoke alarm ASD 10" and the "wireless smoke alarm ASD 20" (also referred to as "product" in these operating instructions). These operating instructions are part of the product.

- You may only use the product if you have fully read and understood these operating instructions.
- Verify that these operating instructions are always accessible for any type of work performed on or with the product.
- Pass these operating instructions as well as all other product-related documents on to all owners of the product.
- If you feel that these operating instructions contain errors, inconsistencies, ambiguities or other issues, contact the manufacturer prior to using the product.

These operating instructions are protected by copyright and may only be used as provided for by the corresponding copyright legislation. We reserve the right to modifications.

The manufacturer shall not be liable in any form whatsoever for direct or consequential damage resulting from failure to observe these operating instructions or from failure to comply with directives, regulations and standards and any other statutory requirements applicable at the installation site of the product.



## 2 Information on safety

### 2.1 Safety messages and hazard categories

These operating instructions contain safety messages to alert you to potential hazards and risks. In addition to the instructions provided in these operating instructions, you must comply with all directives, standards and safety regulations applicable at the installation site of the product. Verify that you are familiar with all directives, standards and safety regulations and ensure compliance with them prior to using the product.

Safety messages in these operating instructions are highlighted with warning symbols and warning words. Depending on the severity of a hazard, the safety messages are classified according to different hazard categories.



## DANGER

DANGER indicates a hazardous situation, which, if not avoided, will result in death or serious injury.



## CAUTION

CAUTION indicates a hazardous situation, which, if not avoided, can result in injury or equipment damage.

## NOTICE

NOTICE indicates a hazardous situation, which, if not avoided, can result in equipment damage.

In addition, the following symbols are used in these operating instructions:



This is the general safety alert symbol. It alerts to injury hazards or equipment damage. Comply with all safety instructions in conjunction with this symbol to help avoid possible death, injury or equipment damage.

## 2.2 Intended use

The product may only be used for private use for the detection of smoke caused by fire. The sensor head smoke alarm ASD can only be operated in conjunction with the wireless mounting base ASD 10 or ASD 20.

Any use other than the application explicitly permitted in these operating instructions is not permitted and causes hazards.

The product may only be used indoors:

- Bedrooms, living room, workrooms
- Children's rooms
- Lounges, hallways and escape ways
- Camping vehicles

Verify that the product is suitable for the application planned by you prior to using the product. In doing so, take into account at least the following:

- All directives, standards and safety regulations applicable at the installation site of the product
- All conditions and data specified for the product
- The conditions of the planned application

In addition, perform a risk assessment in view of the planned application, according to an approved risk assessment method, and implement the appropriate safety measures, based on the results of the risk assessment. Take into account the consequences of installing or integrating the product into a system or a plant.

When using the product, perform all work and all other activities in conjunction with the product in compliance with the conditions specified in the operating instructions and on the nameplate, as well as with all directives, standards and safety regulations applicable at the installation site of the product.

## 2.3 Predictable incorrect application

The product must never be used in the following cases and for the following purposes:

- Bathrooms, shower rooms, kitchens and other rooms which are subject to the formation smoke or vapour
- Areas which are subject to the formation of dust or vapour (for example, garages, workshops)
- In rooms with a ceiling height exceeding 6 m
- In the top area of pointed ceilings/gables since smoke-free air can collect in such areas in the case of fire
- In the vicinity of heat-producing appliances or open fireplaces
- In the vicinity of heating systems and air conditioning systems
- Hazardous area (EX)
  - If the product is operated in hazardous areas, sparks may cause deflagrations, fires or explosions
- Boats

## 2.4 Qualification of personnel

Only persons who are familiar with and understand the contents of these operating instructions and all other pertinent product documentation are authorized to work on and with this product.

## 2.5 Personal protective equipment

Always wear the required personal protective equipment. When performing work on and with the product, take into account that hazards may be present at the installation site which do not directly result from the product itself.

## 2.6 Modifications to the product

Only perform work on and with the product which is explicitly described in these operating instructions. Do not make any modifications to the product which are not described in these operating instructions.

## 3 Transport and storage

The product may be damaged as a result of improper transport or storage.

### NOTICE

#### **INCORRECT HANDLING**

- Verify compliance with the specified ambient conditions during transport or storage of the product.
- Use the original packaging when transporting the product.
- Store the product in a clean and dry environment.
- Verify that the product is protected against shocks and impact during transport and storage.

**Failure to follow these instructions can result in equipment damage.**

---

## 4 Product description

### 4.1 Overview

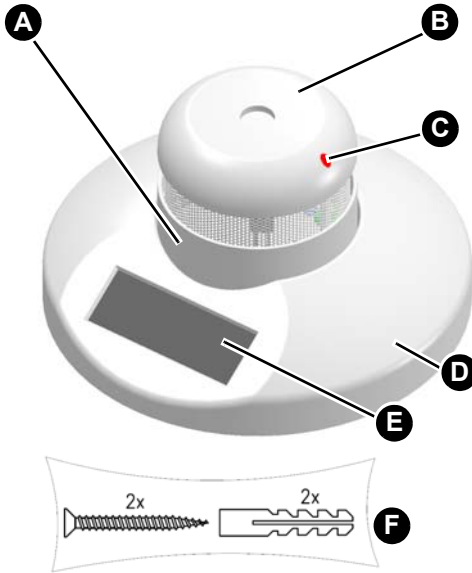

- A. Sensor head smoke alarm ASD
- B. Pushbutton (test button)
- C. Red LED
- D. Wireless mounting base ASD 10/ASD 20
- E. Solar cell
- F. Mounting accessories

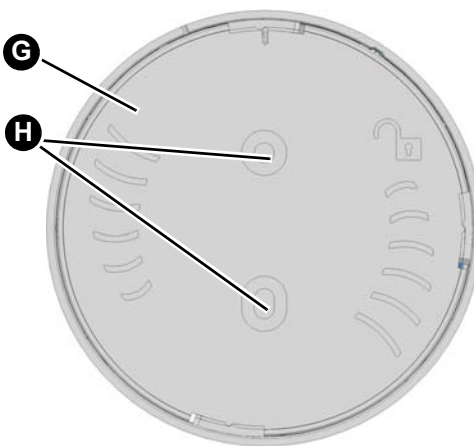

- G. Cover/holder
- H. Fixing holes

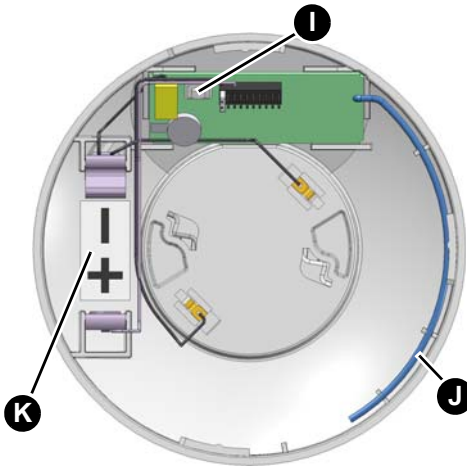

- I. LRN key
- J. Antenna
- K. Battery compartment for optional lithium battery (3.6 V ½ AA)

## 4.2 Dimensions

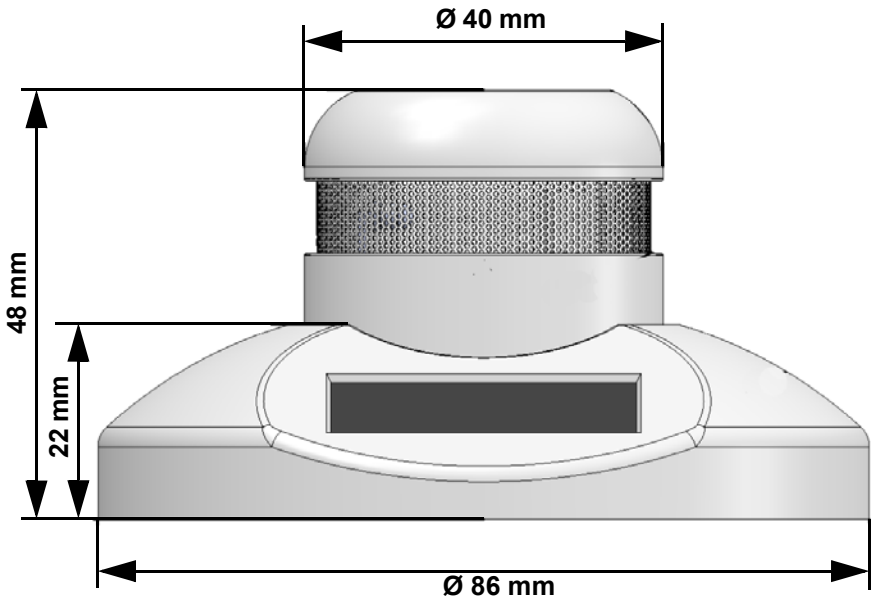

## 4.3 Function

The sensor head smoke alarm ASD can only be operated in conjunction with the wireless mounting base ASD 10 or ASD 20. A solar cell generates the required energy. The sensor head smoke alarm ASD is battery-operated and has a service life of approximately 10 years. A low battery condition is indicated by visual and audible signals.

The product detects the formation of smoke gas and fumes and warns by means of a loud, audible signals (approx. 85 dB).

The state can be checked via an LED:

- Regular operation: LED flashes every 48 seconds
- Increased sampling rate: LED flashes every 2 seconds
- Alarm: LED flashes every 0.5 seconds

The product ASD 10 transmits the following information via EnOcean® wireless:

- State alarm/no alarm (cyclically)
- State transition (immediately)
- Ambient temperature (cyclically)

The product ASD 20 transmits the following information via EnOcean® wireless:

- State alarm/no alarm (cyclically)
- State transition (immediately)
- Battery state (cyclically)

Each product has a unique ID. If multiple products are used, the recipient can distinguish them based on this ID.

## 4.4 Approvals, conformities, certifications

The product complies with:

- EMC Directive (2014/30/EU)
- Low Voltage Directive (2014/35/EU)
- Radio Equipment Directive, RED (2014/53/EU)
- RoHS Directive (2011/65/EU)
- Ecodesign Directive (2009/125/EC)

## 4.5 Technical data

### 4.5.1 Wireless mounting base ASD 10/ASD 20

Parameter	Value
<b>General specifications</b>	
Dimensions (Ø W x H)	86 x 22 mm
Weight	38 g
Housing material	PC/ABS
Colour	White, similar to RAL 9003
Temperature measuring range	0 ... 40 °C, ±1 K
<b>Ambient conditions</b>	
Ambient temperature operation	0 ... 40 °C
Ambient temperature storage	-20 ... 60 °C
Maximum humidity	90 % (non-condensing)
<b>Supply voltage</b>	
Via solar cell	Energy harvesting
Via lithium battery (optional)	DC 3.6 V ½ AA
<b>Electrical data</b>	
Protection class (EN 60730-1; SELV)	III
Degree of protection	IP 30
<b>EnOcean® wireless - ASD 10</b>	
Frequency	868.3 MHz
Transmission power	Max. 10 mW
Range	See chapter "Information on EnOcean® wireless"
EnOcean Equipment Profile (EEP)	A5-30-03



Parameter	Value
<b>EnOcean® wireless - ASD 20</b>	
Frequency	868.3 MHz
Transmission power	Max. 10 mW
Range	See chapter "Information on EnOcean® wireless"
EnOcean Equipment Profile (EEP)	F6-05-02

## 4.5.2 Sensor head smoke alarm ASD

Parameter	Value
Dimensions (Ø W x H)	40 x 43 mm
Smoke alarm type	optical
Application area	Private apartments/houses
Internal battery (not replaceable)	Lithium, 3 V, 1.6 Ah
Service life	10 years with normal operation (1 test per week)
Sound pressure of alarm	85 dB
<b>Ambient conditions</b>	
Ambient temperature operation	4 ... 38 °C
Ambient temperature storage	-20 ... 60 °C
Maximum humidity	90 % (non-condensing)

## 5 Mounting

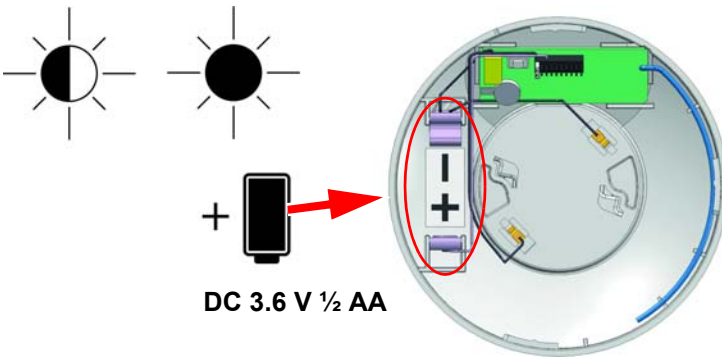
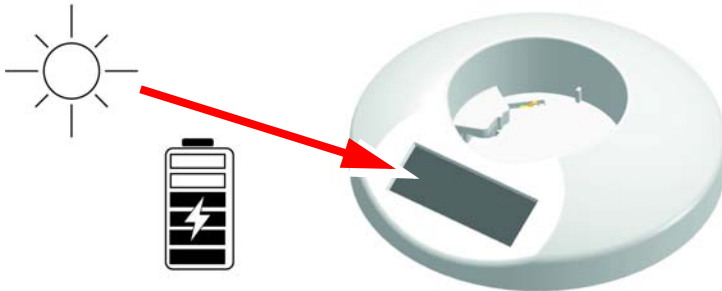
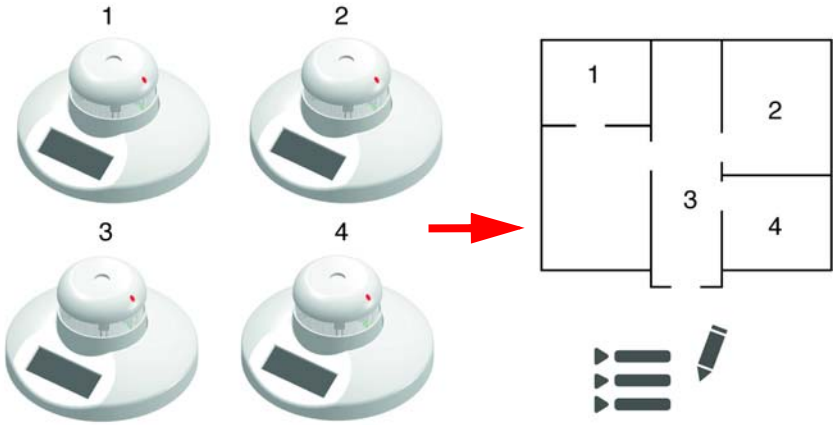

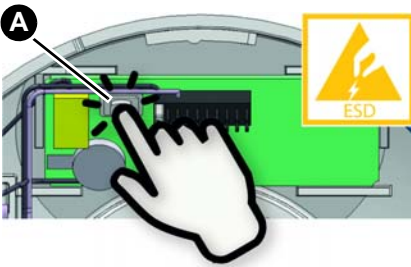

A. LRN key

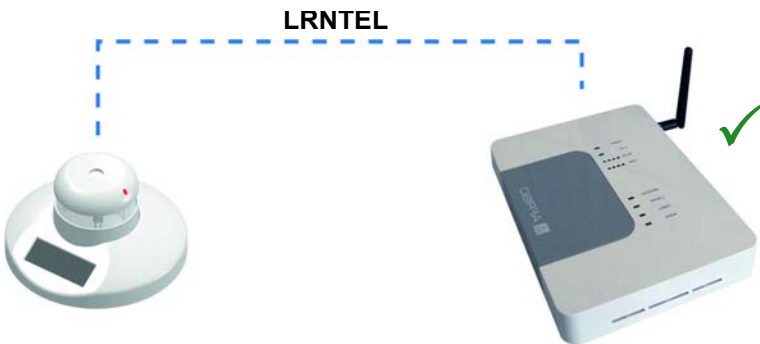

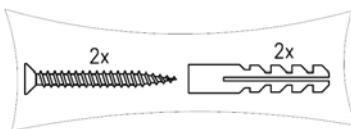
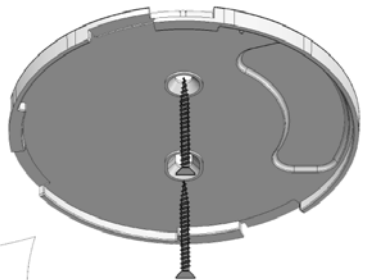
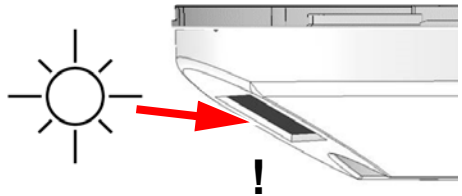
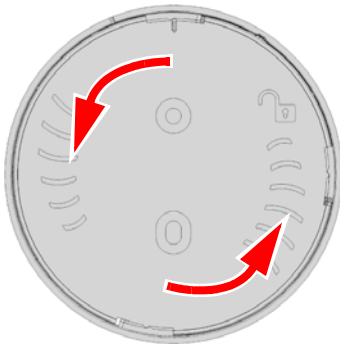
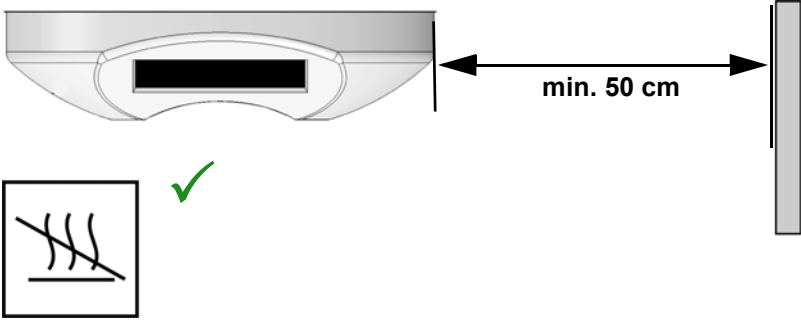

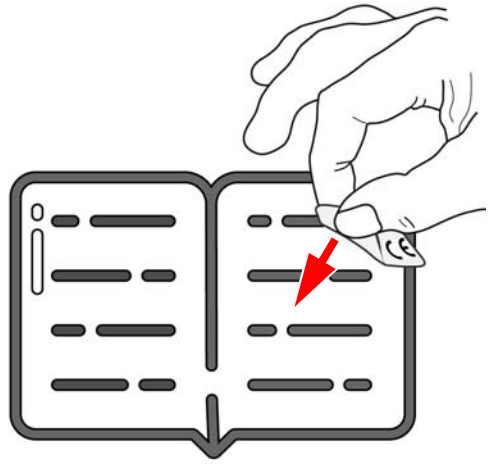
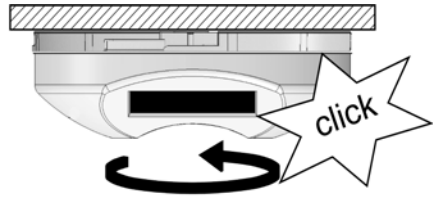
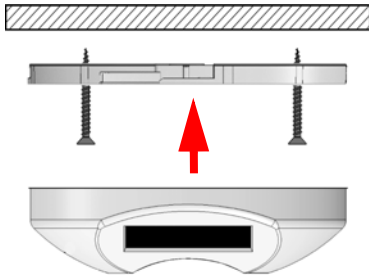

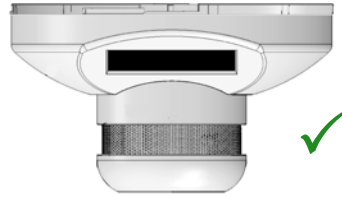
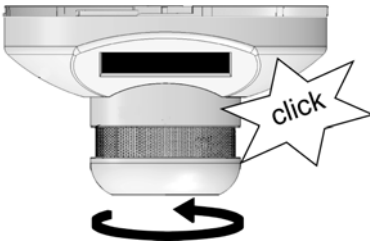
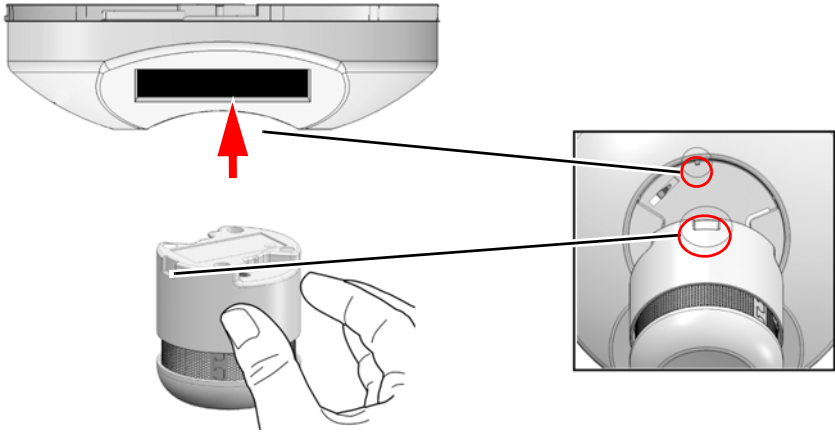

## 6 Commissioning

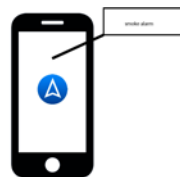
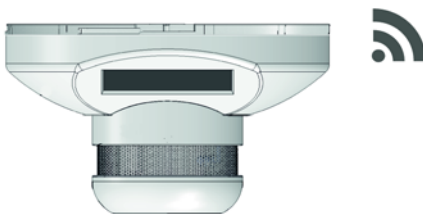
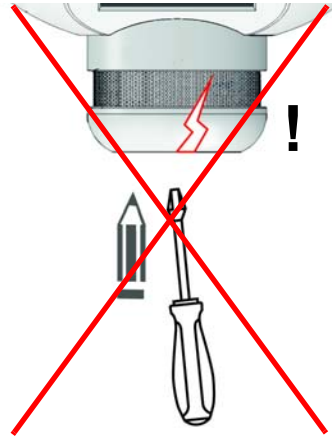
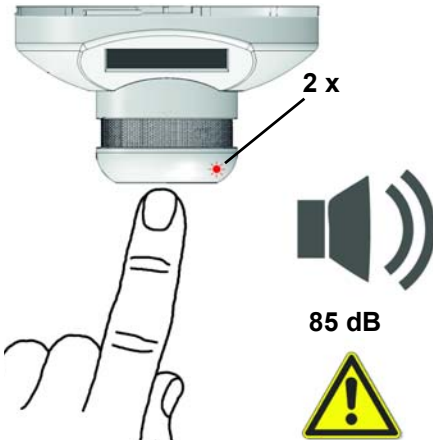

## 7 Alarm

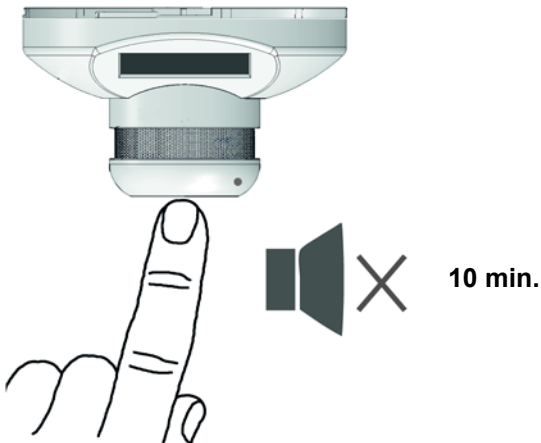
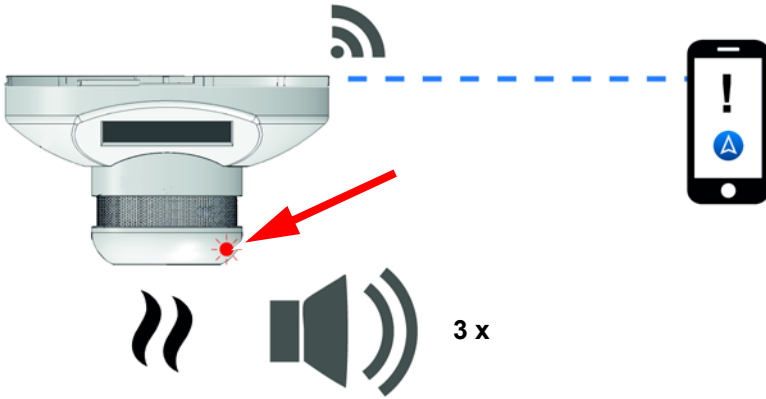



## 8 Maintenance and cleaning

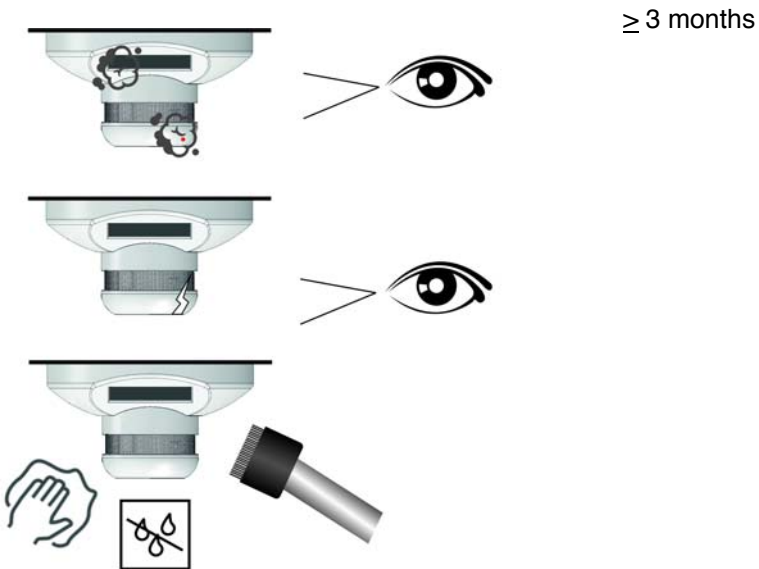

## 9 Troubleshooting

Any malfunctions that cannot be removed by means of the measures described in this chapter may only be repaired by the manufacturer or by qualified persons.

Problem	Possible reason	Repair
No wireless signal	The wireless mounting base ASD 10/ASD 20 is not charged	Place the wireless mounting base ASD 10/ASD 20 into the sunlight for approximately 10 minutes. Insert a lithium battery into the wireless mounting base ASD 10/ASD 20.
	The wireless mounting base ASD 10/ASD 20 has not been properly connected to the AFRI-SOhome gateway	Teach in the wireless mounting base ASD 10/ASD 20 again (see chapter "Mounting").
	Environment of the wireless mounting base ASD 10/ASD 20 has changed (interference)	Check the environment of the wireless mounting base ASD 10/ASD 20 for changes/interference (metal cabinets, furniture/walls repositioned).
A short tone sounds and the red LED flashes every 48 seconds at the sensor head smoke alarm ASD	Battery empty	Replace the sensor head smoke alarm ASD. When this acoustic signal starts, the smoke alarm ASD can be operated for another 30 days or 4 minutes in the case of an alarm.

<b>Problem</b>	<b>Possible reason</b>	<b>Repair</b>
Energy storage module of the wireless mounting base ASD 10/ASD 20 is discharged	Insufficient light	Ensure proper illumination.
	Lithium battery is discharged.	Insert a (new) lithium battery (see "Product description").
Reduced range of the wireless signals	Metal objects or materials containing metal in the vicinity	Keep a minimum distance of 50 cm from objects or walls.
Other malfunctions	-	Contact the AFRISO service hotline

## 10 Decommissioning, disposal

Dispose of the product in compliance with all applicable directives, standards and safety regulations.

### 10.1 Information on disposal

Electronic components must not be disposed of together with the normal household waste.



1. Dismount the product (see chapter "Mounting", reverse sequence of steps).
2. Dispose of the product and of the optional batteries separately.

### 10.2 Information on handling of batteries



## DANGER

### EXPLOSION, FIRE OR TOXIC SUBSTANCES

Incorrect handling of lithium batteries can cause hazards

- Observe the information on handling lithium batteries in this chapter.

**Failure to follow these instructions will result in death or serious injury.**

- Only use the battery type specified in these instructions.
- Do not subject batteries to mechanical stress.
- Never throw batteries into fire.
- Comply with the specified ambient conditions ("Technical data").
- Do not use damaged, deformed or hot batteries.
- Keep batteries out of the reach of children.

## 11 Returning the device

Get in touch with us before returning your product (service@afriso.de).

## 12 Warranty

See our terms and conditions at [www.afriso.com](http://www.afriso.com) or your purchase contract for information on warranty.

## 13 Spare parts and accessories



# NOTICE

### DAMAGE DUE TO UNSUITABLE PARTS

- Only use genuine spare parts and accessories provided by the manufacturer.

**Failure to follow these instructions can result in equipment damage.**

### Product

Product designation	Part no.	Figure
Wireless smoke alarm ASD 10 Wireless smoke alarm ASD 20	61245 61249	
Wireless mounting base ASD 10 Wireless mounting base ASD 20	61247 61253	
Sensor head smoke alarm ASD	61246	

## 14 Information on EnOcean® wireless

### 14.1 Range of EnOcean® wireless

Visit [www.enocean.com](http://www.enocean.com) for further information on range planning with EnOcean®.

### 14.2 Additional information on EnOcean® wireless systems

Additional information on planning, installation and operation of EnOcean® wireless systems can be found at [www.enocean.com](http://www.enocean.com).

- Wireless standard
- Wireless technology
- AN001
- AN102
- AN103
- AN201

### 14.3 Features of the EnOcean® technology

Visit [www.afrisohome.de](http://www.afrisohome.de) for documents on EnOcean® technologies.

A variety of videos on AFRISO products can also be found on the AFRISO YouTube channel.

## 15 Appendix

### 15.1 Annual function test confirmation

Installation site (example: Hallway ground floor)	Date				

## 15.2 EU Declaration of Conformity

		
<b>Technik für Umweltschutz</b> Messen, Regeln, Überwachen.		
<b>EU - Konformitätserklärung</b> <i>EU Declaration of Conformity / Déclaration EU de conformité /</i> <i>Declaración de conformidad CE / Declaração de conformidade CE /</i> <i>Deklaracja zgodności UE</i>		
<b>Formblatt</b> <b>FB 27 - 03</b>		
<p>Name und Anschrift des Herstellers: <u>AFRISO-EURO-INDEX GmbH, Lindenstraße 20, 74363 Göglingen</u>  <i>Manufacturer / Fabricant / Fabricante / Nome e endereço do fabricante / Producent:</i></p> <p>Erzeugnis: <u>Funk-Montagesockel für Rauchwarnmelder und Heizmelder</u>  <i>Product / Produit / Producto / Produto / Produkt:</i></p> <p>Typenbezeichnung: <u>ASD 10, ASD 20, AHD 10, AHD 20</u>  <i>Type / Type / Tipo / Tipo / Typ:</i></p> <p>Betriebsdaten: <u>Solar 3V oder Batterie 3.6V</u>  <i>Techn. Details / Caractéristiques / Características / Detalhes técnicos / Dane techniczne:</i></p> <p>Das bezeichnete Erzeugnis stimmt mit den Vorschriften folgender Europäischer Richtlinien überein:  <i>The above mentioned product meets the requirements of the following European Directives:</i>  <i>Le produit mentionné est conforme aux prescriptions des Directives Européennes suivantes:</i>  <i>El producto indicado cumple con las prescripciones de las Directivas Europeas siguientes:</i>  <i>O produto indicado cumpre com as prescrições das seguintes Diretivas Europeias:</i>  <i>Wymieniony wyżej produkt spełnia wymagania następujących Dyrektyw Europejskich:</i></p> <p><b>Elektromagnetische Verträglichkeit (2014/30/EU)</b>  <i>Directive Electromagnetic Compatibility / Directive compatibilité électromagnétique / Directiva compatibilidad electromagnética / Diretiva sobre compatibilidade eletromagnética / Dyrektywa kompatybilności elektromagnetycznej</i>  <u>EN 301489-1:V2.2.0, EN 301489-3:V2.1.1</u></p> <p><b>Niederspannungsrichtlinie (2014/35/EU)</b>  <i>Low Voltage Directive / Directive basse tension / Directiva baja tensión / Diretiva sobre baixa tensão /</i>  <i>Dyrektywa niskonapięciowa</i>  <u>DIN EN 62368-1:2014/+AC:2017</u></p> <p><b>Radio Equipment Directive, RED (2014/53/EU)</b>  <i>RED Directive / Directive RED / Directiva RED / Diretiva RED / Dyrektywa radiowa</i>  <u>EN 300220-2-V3.1.1, EN 62479:2010</u></p> <p><b>RoHS-Richtlinie (2011/65/EU)</b>  <i>RoHS Directive / Directive RoHS / Directiva RoHS / Diretiva RoHS / Dyrektywa RoHS</i>  <u>EN IEC 63000:2018</u></p> <p>Unterzeichner: <u>Dr. Späth, Geschäftsführer Technik</u>  <i>Signed / Signataire / Firmante /</i>      <i>Technical Director / Diretor Técnico / Dyrektor Techniczny</i>  <i>Assinado por / Podpisal:</i></p> <p style="text-align: center;">    <small>AFRISO-EURO-INDEX GmbH Lindenstraße 20 • 74363 Göglingen Tel. +49 7143 152-0 • www.afri-so.de</small>  <b>Unterschrift / Signature / Firma / Assinatura / Podpis</b> </p> <p style="text-align: center;"> <u>9.2.2021</u>  <small>Datum / Date / Fecha / Data</small> </p>		
Version: 3 Index: 2	AFRISO-EURO-INDEX GmbH D-74363 Göglingen	Seite 1 von 1



## 15.3 Test report CNPP

 Prévention et maîtrise des risques	<b>GRUPE CNPP</b> <b>LPMES / LEI</b> <b>LABORATOIRE ELECTRONIQUE INCENDIE</b> Route de la chapelle Réanville CD 64 – CS22265 F27950 SAINT-MARCEL Téléphone : +33 (0)2 32 53 64 49 Télécopie : +33 (0)2 32 53 64 96
---	---

**AVIS TECHNIQUE / TECHNICAL ASSESSMENT N° FE 21 00 07**

<b>DEMANDE PAR</b> <i>REQUIRED BY</i>	<b>: CNPP Cert</b> Route de la chapelle Réanville CD 64 – CS22265 F27950 – SAINT MARCEL
<b>DOSSIER ENREGISTRE SOUS LE N°</b> <i>DOSSIER REGISTERED UNDER THE N°</i>	<b>: FL2021-27-A201</b>
<b>DENOMINATION TECHNIQUE</b> <i>TECHNICAL DESIGNATION</i>	<b>: Dispositif d'Alarme de Fumée</b> <b>Smoke alarm device</b>
<b>REFERENCE COMMERCIALE</b> <i>COMMERCIAL REFERENCE</i>	<b>: ASD10 / ASD20</b>
<b>MARQUE COMMERCIALE</b> <i>COMMERCIAL MARK</i>	<b>: CAVIUS</b>
<b>CONSTRUCTEUR</b> <i>MANUFACTURER</i>	<b>: CAVIUS APS</b>

---

**DESCRIPTION DES EVOLUTIONS DECLAREES PAR LE CONSTRUCTEUR (voir § I)**  
*DESCRIPTION OF THE EVOLUTIONS DECLARED BY THE MANUFACTURER (see § I)*

**EXAMEN**  
**EXAMINATION**

- Conforme à la description et aux plans du Constructeur spécifiés dans la liste du rapport d'essais N° :  
*The product complies with the Manufacturer's description and drawing plans specified in the tests report N°:*  
**FE 17 00 01 B**

---

**CONCLUSION**  
**CONCLUSION**

Suite à l'analyse des évolutions déclarées par le constructeur mentionnées au § I, le produit identifié ci-dessus, satisfait aux exigences de l'annexe ZA de la norme EN 14604, (2005)+AC(2008).  
*Following the analysis of the evolutions declared by the manufacturer mentioned in §I the product identified above fulfills the requirements of the annex ZA of the EN 14604 (2005)+AC(2008) standard.*

<input style="width: 100%; height: 20px;" type="text"/>  <input style="width: 100%; height: 20px;" type="text"/>	<b>AVIS TECHNIQUE ETABLI LE</b> : 27 mai 2021 <b>DATE OF TECHNICAL ASSESSMENT</b>	 Groupe CNPP Laboratoire Electronique Incendie Pour le Directeur des Laboratoires et par obligation Responsable Essais Jean FORESTIER Signature électronique
--	--	---

Essais effectués dans le cadre d'une demande de certificat de constance des performances selon le Règlement (UE) 305/2011 – Règlement Produit de Construction  
*Tests carried out in view of delivery of a certificate of constancy of performance according to the Regulation (EU) 305/2011 - Construction Product Regulation*

Trame AT FE – EN 14604 – Version 6

Ce document atteste uniquement des caractéristiques de l'échantillon soumis aux essais ou à l'examen du laboratoire et ne préjuge pas des caractéristiques de produits similaires. Il ne constitue donc pas une certification de produit au sens de l'article 1115-27 du code de la consommation, ni un appuiement de quelque nature que ce soit. La reproduction de ce document n'est autorisée, sauf approbation préalable du CNPP, que sous sa forme intégrale. Le CNPP décline toute responsabilité en cas de reproduction ou de publication non conforme. Le CNPP se réserve le droit d'utiliser les enseignements qui résultent du présent document pour les inclure dans des travaux de synthèse ou d'intérêt général pouvant être publiés par ses soins.

This document gives evidence only of characteristics of the sample subjected to the tests carried out or scrutinized by the laboratory and does not prejudge characteristics of similar products. It does not thus constitute a certification of products in the sense of the article 1115-27 of the code of the consumption, or an approval whatever relation it is. The reproduction of this document is not authorized, except preliminary approval of CNPP, only under its complete form. CNPP declines any responsibility in case of reproduction or not corresponding publication. CNPP reserves the right to use the information which result from the present document to include them in works of synthesis or general interest, the envisaged works which can be published by its case.

CNPP Entreprise SARL, au capital de 8 500 000 € - SIRET 34290125300050 - N° TVA FR 50342901253 - Code NAF 8559A - RC Evreux 1987900299  
 Siège Social : CS 22265 - F 27950 SAINT-MARCEL - N° formateur 23270036727 [www.cnpp.com](http://www.cnpp.com)

**I - DESCRIPTION DES EVOLUTIONS DECLAREES PAR LE CONSTRUCTEUR**  
*DESCRIPTION OF THE EVOLUTIONS DECLARED BY THE MANUFACTURER*

- Création des variantes du dispositif d'alarme de fumée :  
*Creation of variants of smoke alarm device:*  
**2301-001**

Celles-ci ne diffèrent que par les points suivants :  
*This one differs only by the following points:*

Référence / Reference: **ASD10**

- Transmission des informations suivantes par liaison radio « EnOcean » :
  - Etat alarme/Pas alarme (cyclique)
  - Température ambiante(cyclique)
  - Etat de transition (immédiat)
- *Transmit the following informations via « EnOcean » wireless :*
  - *State alarm/no alarm (cyclically)*
  - *Ambient temperature (cyclically)*
  - *State transition (immediately)*

Référence / Reference: **ASD20**



- Transmission des informations suivantes par liaison radio « EnOcean » :
  - Etat alarme/Pas alarme (cyclique)
  - Etat de la batterie (cyclique)
  - Etat de transition (immédiat)
- *Transmit the following informations via « EnOcean » wireless :*
  - *State alarm/no alarm (cyclically)*
  - *Battery state (cyclically)*
  - *State transition (immediately)*

Les résultats sont extrapolés du rapport d'essais N°:  
*The results are extrapolated from the tests report N°:*  
**FE 17 00 01 B (19/04/2021)**

Essais effectués dans le cadre d'une demande de certificat de constance des performances  
selon le Règlement (UE) 305/2011 – Règlement Produit de Construction  
*Tests carried out in view of delivery of a certificate of constancy of performance according  
to the Regulation (EU) 305/2011 - Construction Product Regulation*

Trame AT FE – EN 14604 – Version 6

## 15.4 CNPP certificate

 <b>CERTIFICAT DE CONSTANCE DES PERFORMANCES</b>		
<b>1116-CPR-131-1</b>		
<i>Conformément au règlement (UE) N°305/2011 du 09/03/2011 établissant les conditions harmonisées de commercialisation pour les produits de construction (Règlement Produits de Construction – RPC), il a été établi que les produits de construction désignés ci-dessous :</i>		
<b>ASD10 / ASD20 – AFRISO</b> <b>(Dispositif d’alarme de fumée)</b>		
<b>Source principale d’alimentation :</b>	<b>Interne au dispositif par pile lithium 3V (10 ans)</b>	
	<b>DURACELL ULTRA 123 – 1500 mAh</b> <b>HUDIBERUI CR123A – 1600 mAh</b> <b>PANASONIC CR123A – 1400 mAh</b>	
<b>Type de montage :</b>	<b>Mur, Plafond</b>	
<b>Liaison radio (autre que DAF-DAF) :</b>	<b>Oui</b>	
<b>Options avec exigences :</b>	<b>Indicateur d’alarme individuelle :</b> <b>Raccordement à des dispositifs auxiliaires externes :</b> <b>Dispositif d’alarme de fumée interconnectable :</b> <b>Dispositif de neutralisation d’alarme :</b> <b>D.A.F. destiné aux véhicules de type camping-cars :</b>	<b>Oui</b> <b>Oui</b> <b>Non</b> <b>Oui</b> <b>Oui</b>
<i>mis sur le marché par</i> <b>AFRISO-EURO-INDEX GmbH</b> Lindenstraße 20 – 74363 Güglingen – ALLEMAGNE <i>et produits dans l’unité de fabrication</i> <b>BAO JIE Electronic</b> 101, 201, 301, 401, 501 No. 12 Dongcai Industrial Zone, Gushu Community Xixiang Street – BAO AN District – SHENZHEN – CHINE		
<i>font l’objet par le fabricant d’un contrôle de production en usine (CPU) et d’essais sur des échantillons prélevés dans l’unité de fabrication selon un plan d’essais pré-établi,</i> <i>En sa qualité d’organisme certificateur notifié, CNPP Cert. a réalisé les essais de type initiaux pour les caractéristiques concernées du produit ainsi que l’inspection initiale de l’usine et du CPU. Il exerce la surveillance continue du CPU (évaluation et acceptation).</i>		
<b>Ce certificat garantit que toutes les dispositions concernant l’évaluation et la vérification de la constance des performances suivant le système 1 et les caractéristiques décrites en annexe ZA des normes EN 14604 : 2005/AC : 2008 ont été appliquées et que les produits satisfont aux exigences requises.</b>		
<i>Ce certificat, délivré initialement le 31/05/2021, demeure valide tant que les conditions fixées dans les spécifications techniques harmonisées citées en référence ou les conditions de production ou le CPU lui-même n’ont pas été modifiés de façon significative.</i>		
Le 31/05/2021 <b>Amaury LEQUETTE</b> Directeur CNPP Cert.		
	CNPP Cert. organisme certificateur (NB 1116) reconnu par les professionnels de la sécurité et de l’assurance Route de la Chapelle Réanville - CD 64 - CS 22265 - F 27950 LA CHAPELLE-LONGUEVILLE Tél. : +33 (0)2 32 53 63 63 - E.mail : certification@cnpp.com - www.cnpp.com	

**CERTIFICATE OF CONSTANCY OF PERFORMANCE**

1116-CPR-131-1

In compliance with Regulation (EU) N°305/2011 of 09/03/2011 laying down harmonised conditions for the marketing of construction products (Construction Products Regulation – CPR), it has been stated that the construction products below:

**ASD10 / ASD20 – AFRISO  
(Smoke alarm device)**

Normal power source:	Internal to the device by lithium battery of 3V (10 years)	
	DURACELL ULTRA 123 - 1500 mAh HUIDERUI CR123A - 1600 mAh PANASONIC CR123A - 1400 mAh	
Type of mounting:	Wall, Ceiling	
Radio link (other than SAD-SAD):	Yes	
Options with requirements:	Individual alarm indicator:	Yes
	Connection of external ancillary devices:	Yes
	Inter-connectable smoke alarm device:	No
	Alarm silence facility:	Yes
	Smoke alarm device for leisure accommodation vehicles:	Yes

placed on the market by

**AFRISO-EURO-INDEX GmbH**  
Lindenstraße 20 – 74363 Guglingen – GERMANY

and produced in the factory

**BAO JIE Electronic**  
101, 201, 301, 401, 501 No. 12 Dongcai Industrial Zone, Gushu Community Xixiang Street –  
BAO AN District – SHENZHEN – CHINA

are submitted by the manufacturer to a factory production control (FPC) and to further testing of samples taken at the factory in accordance with a prescribes test plan,

The approved body, CNPP Cert., has performed the initial type-testing for the relevant characteristics of the product, the initial inspection of the factory and of the FPC and performs the continuous surveillance, assessment and approval of the FPC.

**This certificate attests that all provisions concerning the assessment and verification of constancy of performance according to system 1 and the characteristics described in ZA annex of the standards EN 14604 : 2005/AC : 2008 were applied and that the product fulfills all prescribed requirements.**

This certificate was first issued on **31/05/2021** and remains valid as long as the conditions laid down in the harmonised technical specification in reference or the manufacturing conditions in the factory or the FPC itself are not modified significantly.

On 31/05/2021

**Amoury LÉQUETTE**  
Manager of CNPP Cert.



CNPP Cert. certification body (NB 1116)  
recognized by the security and insurance professionals  
Route de la Chapelle Réarville - CD 64 - CS 22265 - F 27950 LA CHAPELLE-LONGUEVILLE  
Tel. : +33 (0)2 32 53 63 63 - E-mail : certification@cnpp.com - www.cnpp.com

