

DE Montage- und Bedienanleitung

EN Installation and operating instructions

ES Instrucciones de la instalación y de funcionamiento

FR Instructions de montage et mode d'emploi

IT Istruzione di montaggio e per l'uso

NL Montagehandleiding en Gebruiksaanwijzing

RU установка и инструкции по эксплуатации

KEUCO

KEUCO GmbH & Co. KG
Oesestraße 36
D-58675 Hemer
Telefon +49 2372 90 4-0
Telefax +49 2372 90 42 36
info@keuco.de
www.keuco.de

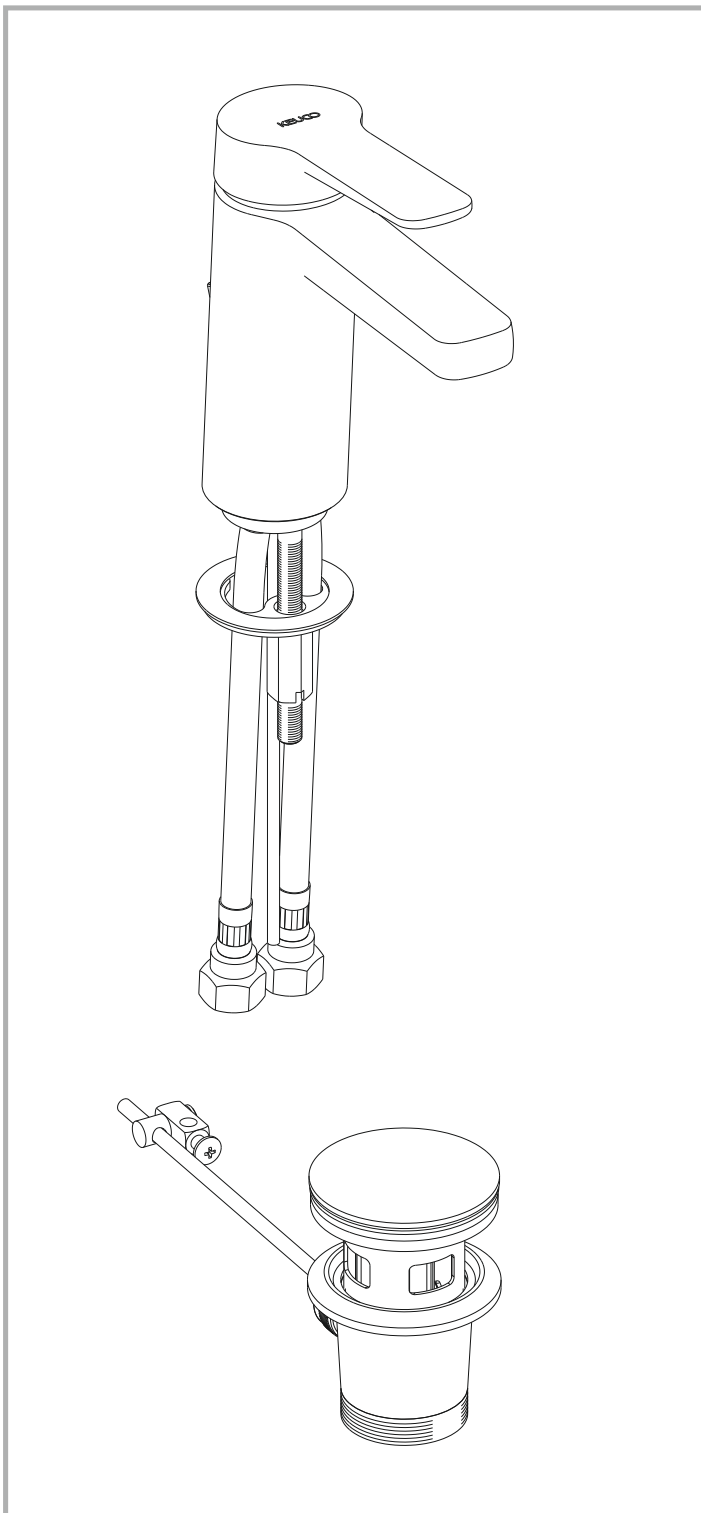

52702 01 0000

Einhebel- Waschtischmischer
mit Zugstangen-Ablaufgarnitur

Single lever basin mixer
with pop-up waste

Mezclador monomando para lavabo
con desagüe automático

Mitigeur monocommande de lavabo
avec vidage

Miscelatore monocomando lavabo
con set di scarico con tirante







Eenhandelmengkraan
met Trekstang en afvoergarnituur

Однорычажный смеситель для умывальника
с гарнитурой для слива и донным клапаном

71993_002
10.2015

DE Wichtige Informationen, bitte unbedingt lesen!

Symbolerklärung

-  **Achtung!** Wichtiger Hinweis zur Warnung vor Personen- oder Sachschäden
-  Hinweis, Tipp oder Verweis
-  Korrekte Montage / Funktionsprüfung
-  Montagedetail beachten
-  Wasser fließt
-  Wasser fließt nicht
-  Kaltwasser
-  Warmwasser

Allgemeine Hinweise

- Eine Gewährleistung in Bezug auf Sicherheit, Funktion und Unversehrtheit des Produktes kann nur geleistet werden, wenn die Hinweise in dieser Anleitung beachtet werden. Bei Missachtung können Sachschäden auftreten. Für Schäden, die durch Nichtbeachtung der Anweisungen eintreten, haftet der Hersteller nicht.
- Die beiliegenden Dokumente sind nach der Montage und Funktionsprüfung dem Benutzer zu übergeben.
- Alle Massangaben sind in Millimeter (mm).
- Technische Änderungen bleiben vorbehalten.









 Hinweise zur Gewährleistung und Pflege entnehmen Sie bitte dem beiliegendem Pflege- und Garantiepäss.

Technische Daten

Fließdruck:	min. 0,5 bar empfohlen 1-5 bar
Betriebsdruck:	max. 10 bar
Prüfdruck:	16 bar
Durchfluss bei 1 - 5 bar Fließdruck:	ca. 6 l/min
Temperatur Warmwassereingang:	max. 80° C
Empfohlen (Energieeinsparung)	60° C
Anzugsmoment Kartuschenmutter	12 - 13 Nm

EN Important information, please read!

Key to symbols

-  **Attention!** Important warning against personal injury or material damage.
-  Note, tip or reference
-  Correct assembly / functional test
-  Note assembly details
-  Water draining
-  Drain closed
-  Cold water
-  Hot water

General instructions

- Safety, functionality and soundness of the product can only be guaranteed if the information in this manual is observed. Ignoring this may cause damage. The manufacturer accepts no liability for damages resulting from non-observance of the instructions.
- The attached documents shall be handed to the user after assembly and functional test.
- All dimensions are given in millimetres (mm).
- Technical changes reserved.









 Please refer to the attached instructions for care and the warranty card for information on warranty and care.

Technical data

Flow pressure:	min. 0,5 bar recommended 1-5 bar
Operating pressure:	max. 10 bar
Test pressure:	16 bar
Flow at 1 - 5 bar flow pressure:	approx. 6 l/min
Temperature, hot water inlet:	max. 80° C
Recommended (energy saving)	60° C
Tightening torque, cartridge nut	12 - 13 Nm

ES Información importante de lectura obligatoria!

Explicación de símbolos

-  **¡Atención!** Indicación importante como advertencia de daños personales o materiales.
-  Indicación, recomendación o referencia
-  Montaje correcto / prueba de funcionamiento
-  Respetar las particularidades de montaje
-  El agua fluye
-  El agua no fluye
-  Agua fría
-  Agua caliente

Indicaciones generales

- Con relación a la seguridad, funcionamiento e integridad del producto, sólo puede ofrecerse una garantía si se respetan las indicaciones incluidas en estas instrucciones. En caso de inobservancia de las mismas pueden originarse daños materiales. El fabricante no se hace responsable por daños derivados de la inobservancia de las instrucciones.
- Los documentos adjuntos han de entregarse al usuario tras el montaje y la prueba de funcionamiento.
- Las medidas se reflejan todas en milímetros (mm).
- Se reserva el derecho de realizar modificaciones









 Las indicaciones sobre garantía y conservación se reflejan en la tarjeta adjunta de conservación y garantía.

Datos técnicos

Presión de flujo:	min. 0,5 bar recomendada 1 - 5 bar
Presión de servicio:	max. 10 bar
Presión de prueba:	16 bar
Caudal con presión de flujo de 1 - 5 bar:	approx. 6 l/min
Temperatura en entrada de agua caliente:	max. 80° C
Recomendada (ahorro de energía)	60° C
Par de apriete de tuerca de cartucho	12 - 13 Nm

FR Informations importantes, à lire impérativement!

Explication des symboles

-  **Attention!** Avertissement important concernant les risques de blessures ou de dommages matériels.
-  Remarque, conseil ou renvoi
-  Conformité du montage / Contrôle de fonctionnement
-  Respecter le détail de montage
-  L'eau coule
-  L'eau ne coule pas
-  Eau froide
-  Eau chaude

Remarques générales

- Les instructions contenues dans ce manuel doivent être respectées pour une garantir sur le fonctionnement, la sécurité et l'intégrité du produit. Un non-respect de ces instructions peut entraîner des dommages matériels. Le fabricant décline toute responsabilité pour les dommages dus à un non-respect de ces consignes.
- Les documents joints doivent être remis à l'utilisateur après le montage et le contrôle du fonctionnement.
- Toutes les indications de mesure sont en millimètres (mm).
- Sous réserve de modifications techniques.

 Les instructions relatives à la garantie et à l'entretien sont fournies dans le livret de garantie et d'entretien joint.

Caractéristiques techniques

Pression dynamique:	min. 0,5 bar
Pression recommandée:	1-5 bar
Pression de service:	max. 10 bar
Pression d'épreuve:	16 bar
Débit à une pression dynamique de 1 à 5 bar:	env. 6 l/min
Température d'entrée d'eau chaude:	max. 80° C
Température recommandée (économies d'énergie):	60° C
Couple de serrage de l'eau de cartouche:	12 à 13 Nm

Spiegazione dei simboli

Attenzione! Importanti avvertimenti per evitare danni a cose e persone.



Note, suggerimenti o rimandi



Montaggio corretto / test di funzionamento



Rispettare le indicazioni di montaggio



L'acqua scorre



L'acqua non scorre



Acqua fredda



Acqua calda

Indicazioni generali

- Si garantisce la sicurezza, il funzionamento e l'integrità del prodotto solo in caso di totale rispetto delle indicazioni presenti in queste istruzioni. Il mancato rispetto delle istruzioni può causare danni materiali. Il produttore non risponde di eventuali danni dovuti al mancato rispetto delle istruzioni.

- I documenti allegati devono essere consegnati all'utilizzatore dopo il montaggio e il collaudo del funzionamento.

- Tutte le indicazioni di misura sono espresse in millimetri (mm).

- Ci si riserva il diritto di apportare modifiche tecniche.



Le istruzioni per la garanzia e la cura sono contenute nel documento di manutenzione e garanzia allegato.

Dati tecnici

Pressione mandata:	min. 0,5 bar consigliata 1 - 5 bar
Pressione di esercizio:	max. 10 bar
Pressione di prova:	16 bar
Portata a 1 - 5 bar Pressione di mandata:	ca. 6 l/min
Temperatura ingresso acqua calda:	max. 80° C
Consigliata (risparmio energetico)	60° C
Momento di torsione blocco cartuccia	12 - 13 Nm

Symboolverklaring

Let op! Belangrijke opmerking voor het risico op letsel of schade.



Opmerking, tip of verwijzing



Correcte montage / functiecontrole



Let op de montagedetails



Water stroomt



Water stroomt niet



Koud water



Warm water

Algemene opmerking

- Een garantie voor de veiligheid, werking en integriteit van het product kan alleen worden gegeven als de instructies in deze handleiding worden opgevolgd. Indien ze niet worden opgevolgd kan schade ontstaan. De fabrikant is niet verantwoordelijk voor schade ontstaan door het niet opvolgen van de aanwijzingen.

- De bijgevoegde documenten moeten na montage en controle van de werking worden overhandigd aan de gebruiker.

- Alle afmetingen zijn in millimeter (mm).

- Technische wijzigingen voorbehouden.



Voor informatie over de garantie en het onderhoud verwijzen wij u naar de bijgevoegde onderhouds- en garantiekaart.

Technische gegevens

Stromingsdruk:	min. 0,5 bar aanbevolen 1-5 bar
Bedrijfsdruk:	max. 10 bar
Testdruk:	16 bar
Doorstroomhoeveelheid bij 1 - 5 bar stromingsdruk:	ca. 6 l/min
Temperatuur ingang warm water:	max. 80° C
Aanbevolen (energiebesparing)	60° C
Aandraaimoment cartouchemoer	12 - 13 Nm

Пояснение условных обозначений



Внимание! Важное указание для предупреждения травм людей или материального ущерба.



Указание, рекомендация или ссылка



Правильный монтаж / Проверка функционирования



Обращать внимание на детали монтажа



Вода течет



Вода не течет



Холодная вода



Горячая вода

Общие указания

-Безопасность, функционирование и сохранность изделия могут быть гарантированы лишь при условии соблюдения указаний данного руководства. При пренебрежении может наступить материальный ущерб. Изготовитель не несет ответственности за ущерб, вызванный несоблюдением данных указаний.

-После монтажа и проверки функционирования прилагаемые документы необходимо передать пользователю.

- Все размеры указаны в миллиметрах (мм).

- Мы оставляем за собой право на технические изменения.

 С гарантийными обязательствами и указаниями по уходу ознакомьтесь, пожалуйста, по прилагаемому паспорту по уходу и гарантийному паспорту.

Технические данные

Давление истечения:	мин. 0,5 бар рекомендовано 1 – 5 бар
Рабочее давление:	макс. 10 бар
Давление при испытании:	16 бар
Проток при давлении истечения 1 – 5 бар:	прим. 6 л/мин
Температура горячей воды на входе:	макс. 80° С
Рекомендовано (энергосбережение)	60° С
Момент затяжки гайки картриджа	12 – 13 Нм

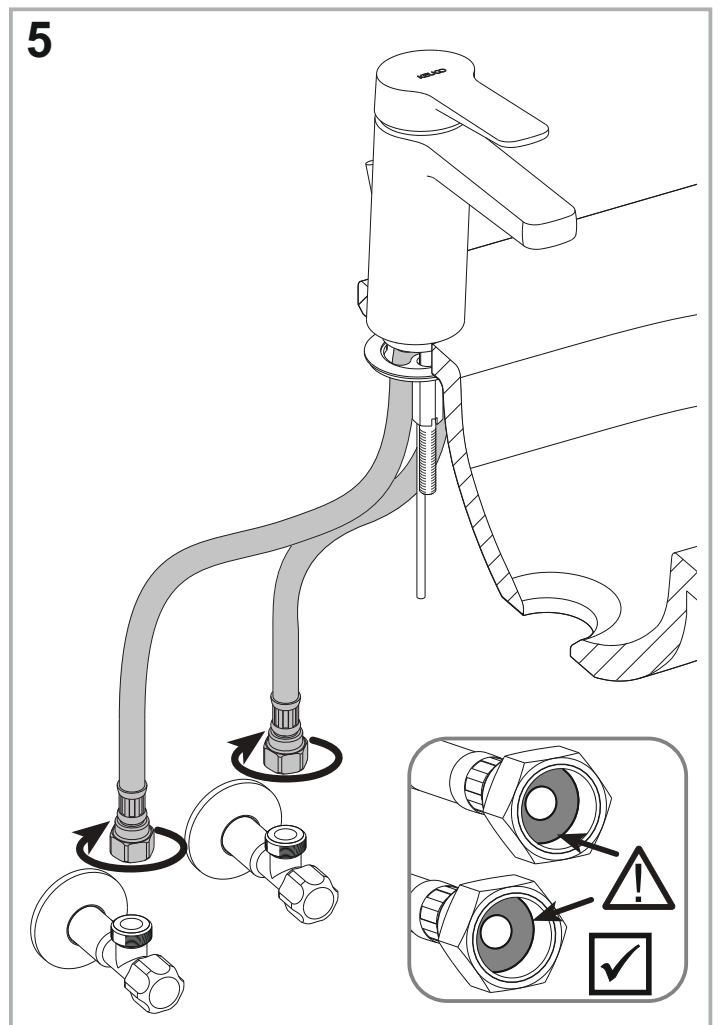
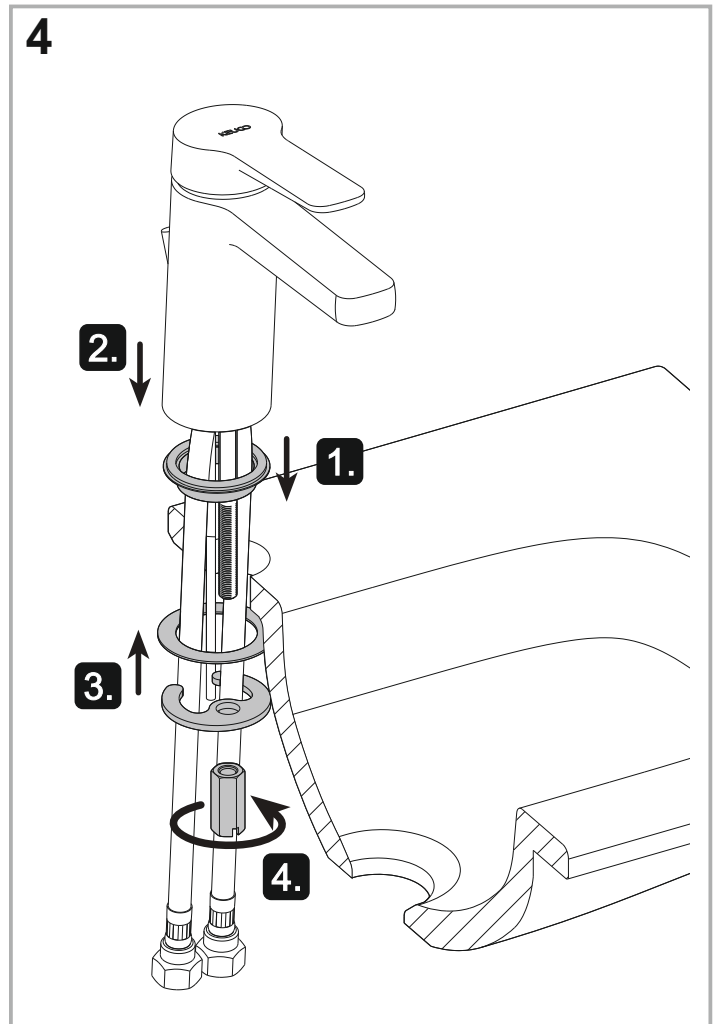
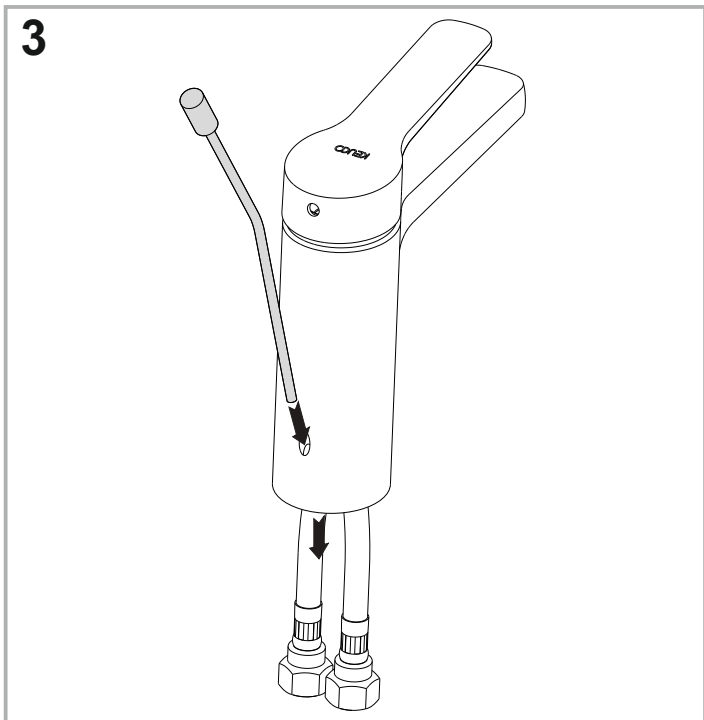
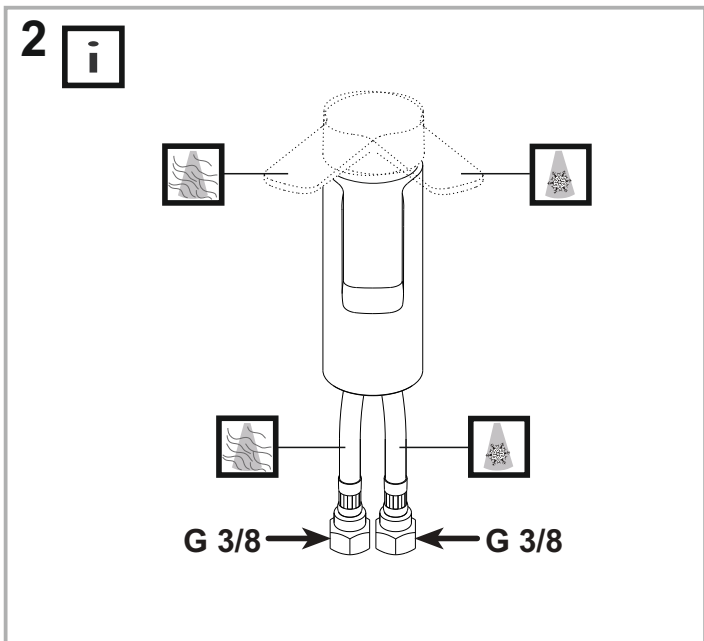
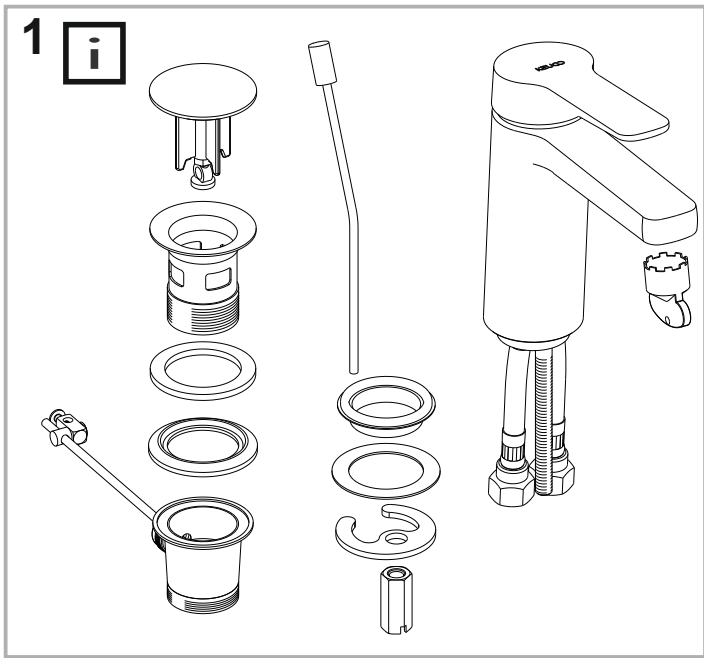

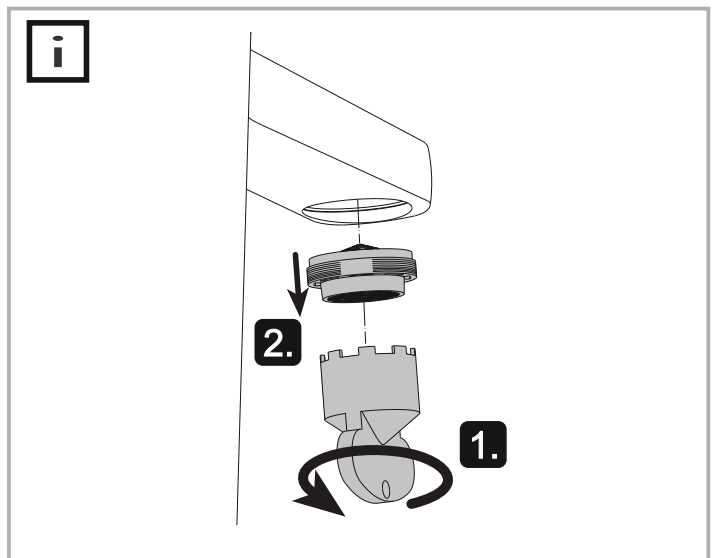
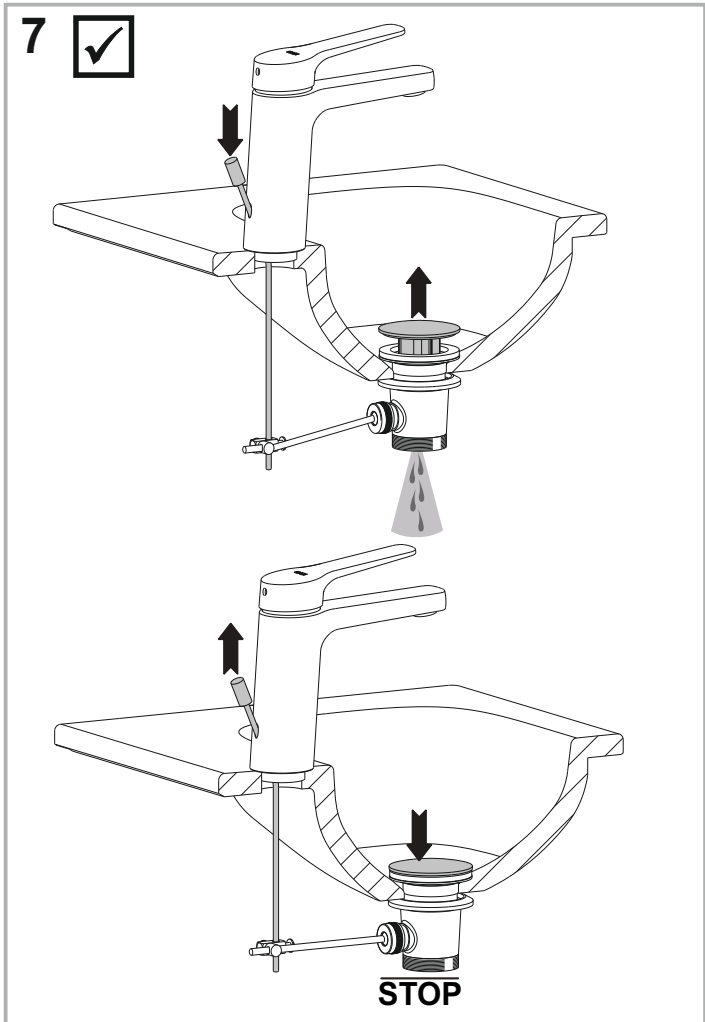
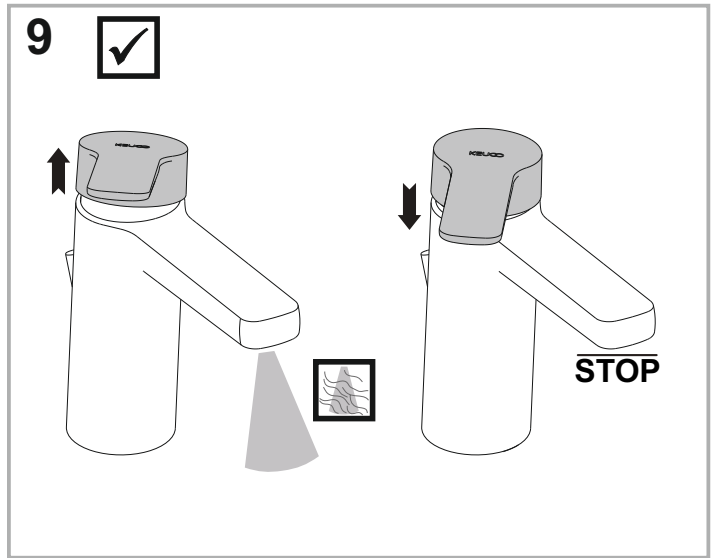
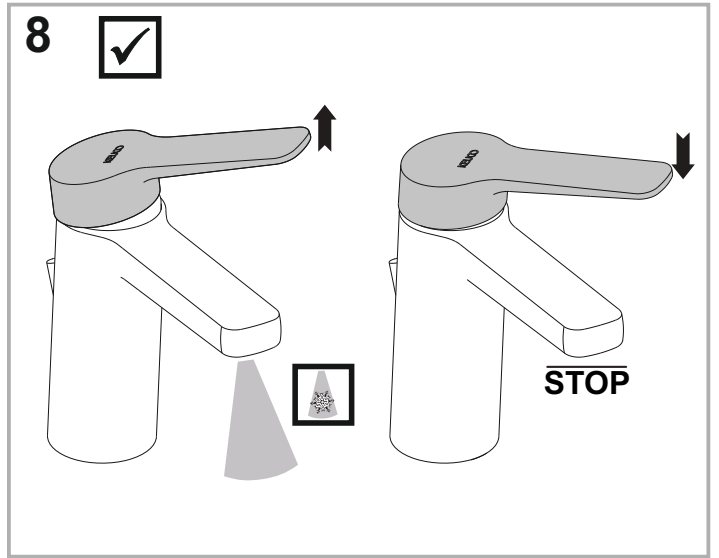
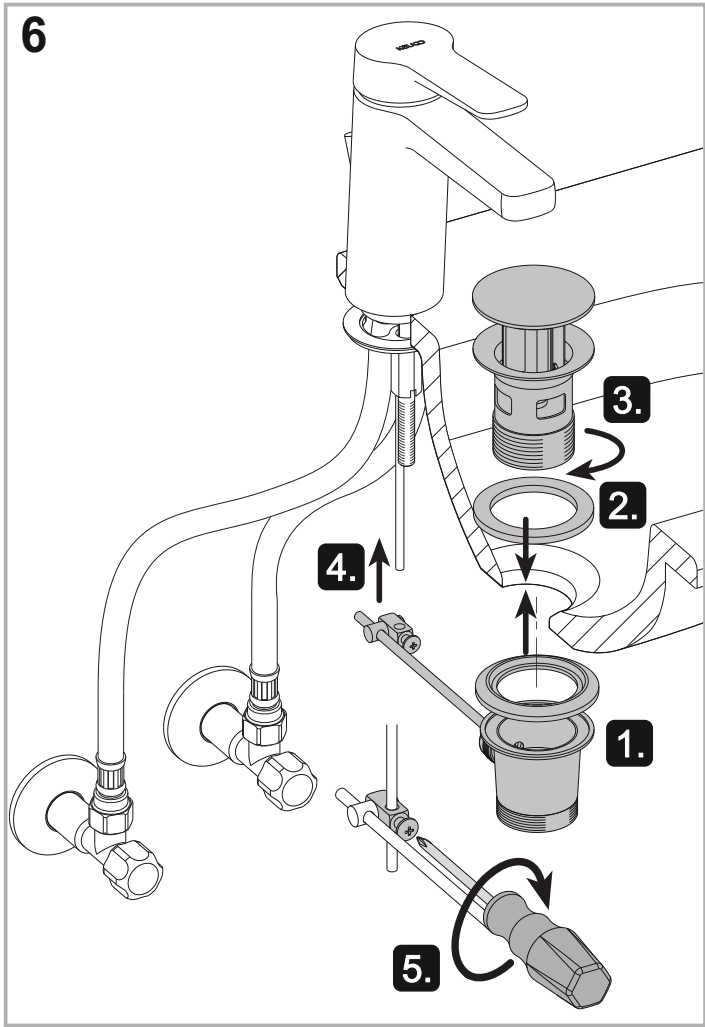

Collection Moll
52702 010000

