

X-Line

33171290000 Waschtischunterbau

PRODUKT

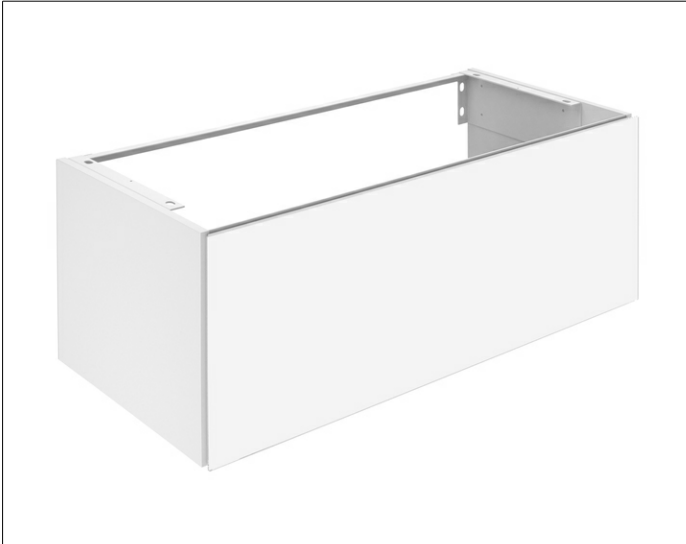

ZEICHNUNG

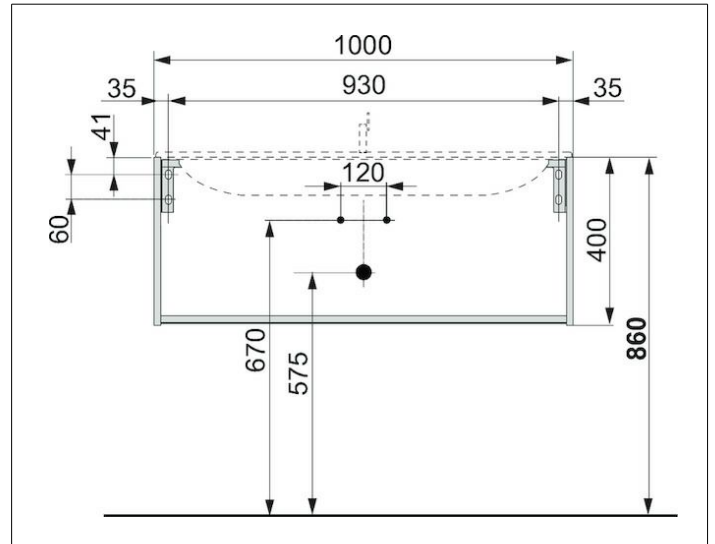

OBERFLÄCHE

inox/inox

ABMESSUNG

1000 x 400 x 490 mm