

X-Line

33295971500 Kristallspiegel

PRODUKT



ZEICHNUNG

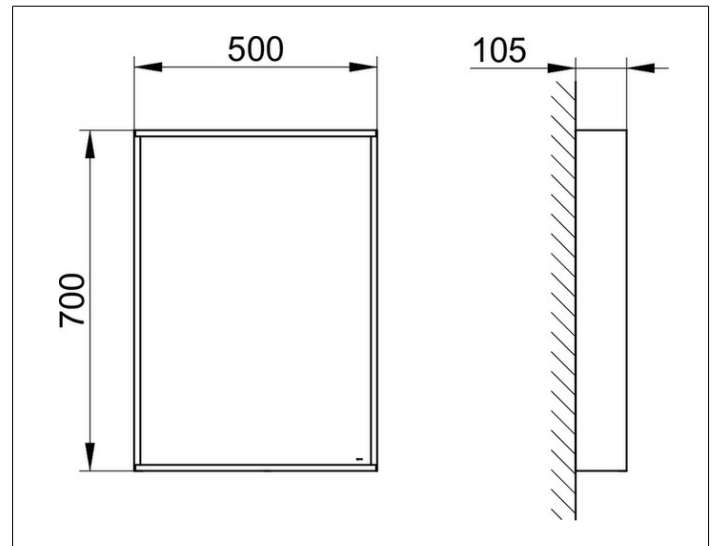

OBERFLÄCHE

vulkanit

ABMESSUNG

500 x 700 x 105 mm