

resideo
CENTRA
DR

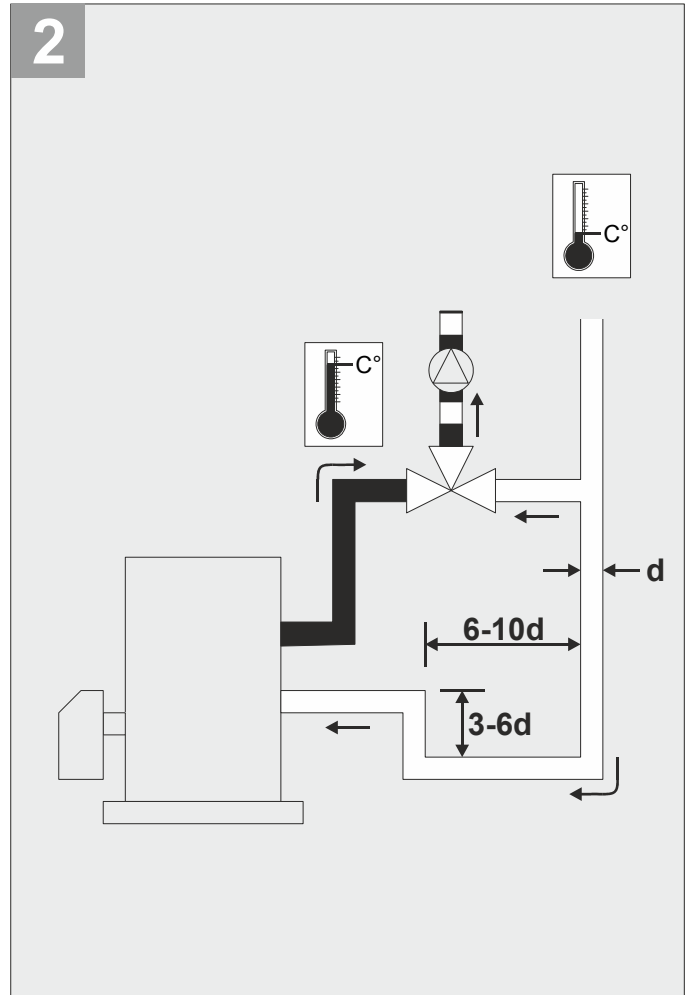

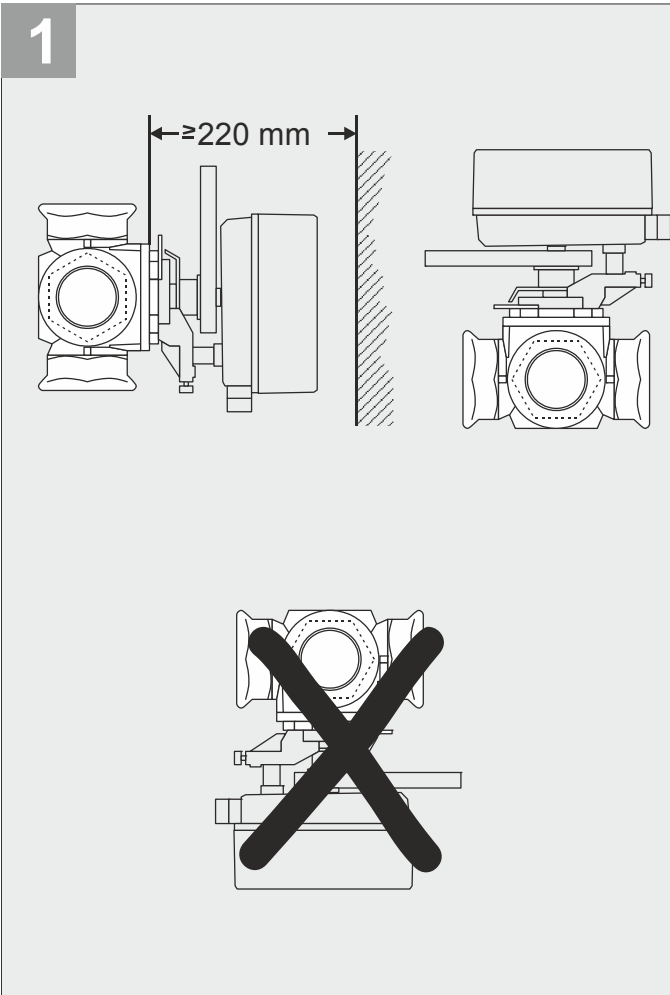

4d

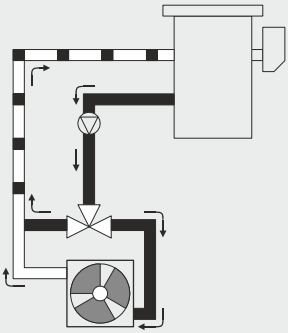
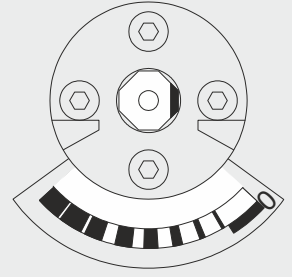
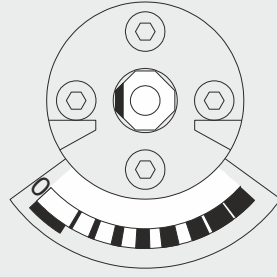
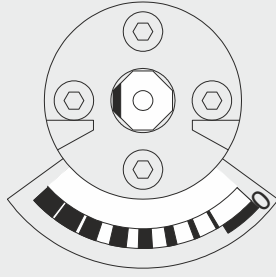
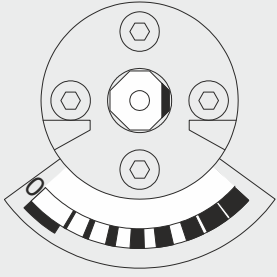
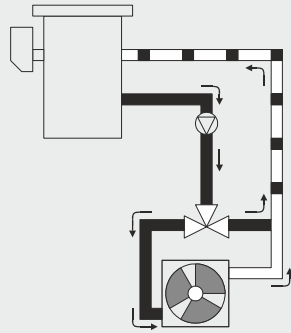

4c

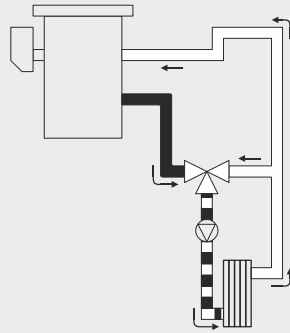

4b

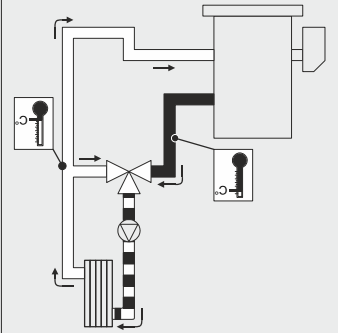

4a

