

Edition 400

31582870100 Waschtischunterbau

PRODUKT



ZEICHNUNG

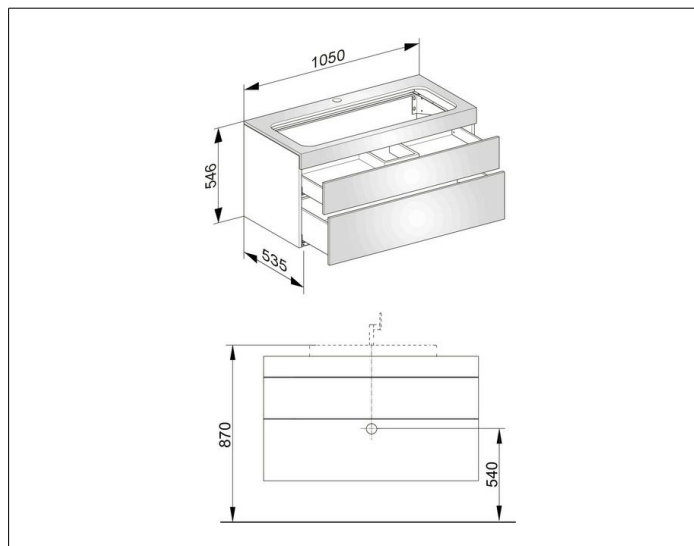

OBERFLÄCHE

Eiche cashmere/Eiche cashmere

ABMESSUNG

1050 x 546 x 535 mm