

Application areas

Drinking water supply for:

- > Domestic kitchens
- > Public areas
- > Offices
- > Cafeterias / bistros
- > Restaurants / hotels







Water system

Zip HydroTap® G5 BCS

Product information



	boiling >  chilled + sparkling >  	G5 BCS 20	G5 BCS 60
Part number:		4100-44590	4100-44591
Number of users:		< 20	< 60
Water connection (thread connection):		G ½" or G ¾" *	G ½" or G ¾" *
Rated pressure [bar]:		2.5 – 7.0	
Boiling water temperature, adjustable [°C]:		68 – 100	68 – 100
Chilled water temperature [°C]:		5 – 10	5 – 10
Boiling water content [litres / cups ¹⁾]:		2.3 / 13	3 / 18
Chilled water capacity [glasses ²⁾ / h]:		75	175
Boiling water capacity [cups ¹⁾ / h]:		100	160
Reheating time [cups ¹⁾ / min]:		1.6	2.6
Standby power consumption [kWh / 24h]:		0.76 ³⁾	0.77 ³⁾
Nominal power at voltage 1~ / N / PE 230 V AC [kW]:		1.96  with plug	2.15  with plug
Compact undersink unit [colour]:		white	
Protection class:		IP 20	
Weight (filled) [kg]:		34	41
Dimensions height × width × depth [cm]:		33.3 × 33.9 × 48.3	33.3 × 39.5 × 46.4

*) Connection hose G ½" with supplied adapter G ¾" 1) Standard cup with 167 ml 2) Standard glass with 200 ml 3) At 12 hours in standby mode

Description

- > Undersink water system, dispenses filtered boiling hot water and chilled still or sparkling drinking water for direct connection to the water supply
- > Touch display for menu navigation, for activating the energy saver modus and scalding protection as well as temperature setting of the water
- > With R290 coolant to meet the latest environmental and climate protection requirements
- > Easy-to-replace sub-micron particle filter cartridge with activated carbon filter, filters hazardous substances > 0.2 micron and improves the taste of water
- > Leakage protection system
- > Various electronic taps with safety function and button operation selectable

Note on carbonation function ^{N) SN)}

The CO₂ bottle for producing sparkling water is not included in the scope of supply. This is obtainable from retail outlets or specialist gas dealers. Pressure reducers are available for either SodaClub CO₂ bottles or standard commercial CO₂ bottles with W 21.8 × 1/14 RH thread.

N) Note: the total quantity of sparkling water depends on the CO₂ bottle used. The carbon dioxide content is a maximum of 5 g per litre, corresponding to medium sparkling water.
SN) Safety note: It must be ensured that an uncontrolled escape of CO₂ gas cannot build up to a hazardous level. There must be a minimum room space of 6.8 square metres per 1 kg CO₂ with a ceiling height of 2.5 m.

Subject to technical changes and version changes. Errors and omissions excepted. Date of publication: 04.22

Profitability comparison (Source: Internet comparison, 18.11.2018)

The comparison shows the total costs of the various systems including purchase, energy and maintenance costs over 5 years of use in Germany. Ideal for use in the office.

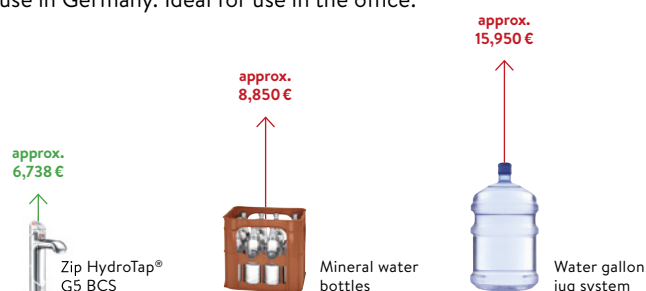

Calculation basis

Number of users:	15 persons
Number of days in use:	230 working days per year
Usage:	0.9 litres / person and day
Drinking water costs:	4 € per 1,000 litres
Mineral water bottles:	570 € per 1,000 litres
Water gallon jugs:	950 € per 1,000 litres

Water system

Zip HydroTap® G5 BCS

Installation



Daily user requirements and the available space in the cabinet below the selected special tap should be considered when selecting the appropriate model. The example below shows the installation with Zip HydroTap® G5 BCS 20.

Measurements in mm

Assembly and operating instructions must be observed upon installation.

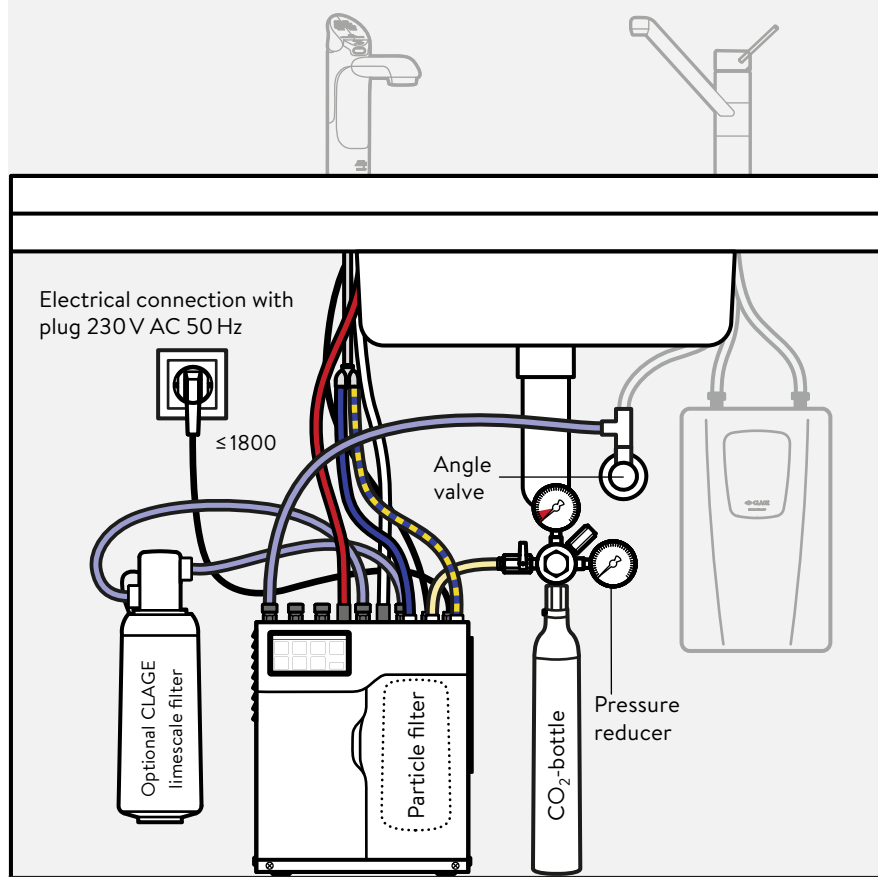

Unit dimensions:
(height × width × depth)

Zip HydroTap® G5 BCS 20
333 × 339 × 483 mm (illustration left)

Zip HydroTap® G5 BCS 60
333 × 395 × 464 mm (without illustration)

.....

Top clearance for undersink unit
(lower edge sink or drawers)
min. 200 mm

Right and left clearance for unit
min. 50 mm

Water system Zip HydroTap® G5 BCS Installation

Option 1: Tap "Classic BCS"

Measurements in mm

For the operation of the water system Zip HydroTap® G5 BCS you need a suitable tap, for example the tap "Classic BCS".

Assembly and operating instructions must be observed upon installation.

NEW!

Now also available as **Touch-Free** option with IR sensors for no-touch operation. Requires min. 10 cm free space around the sensor head.

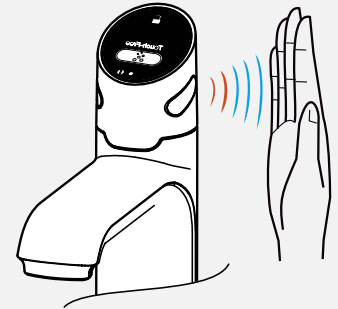

NEW!

Now also available as option **Classic Plus** with waterproof rubber surface and separate quantity fill button.

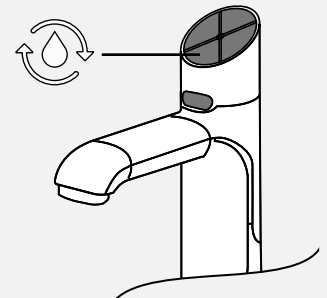

Drill hole diameter
for the tap

Ø 35.5
max. 50
min. 25

Ø 46
126
208

116

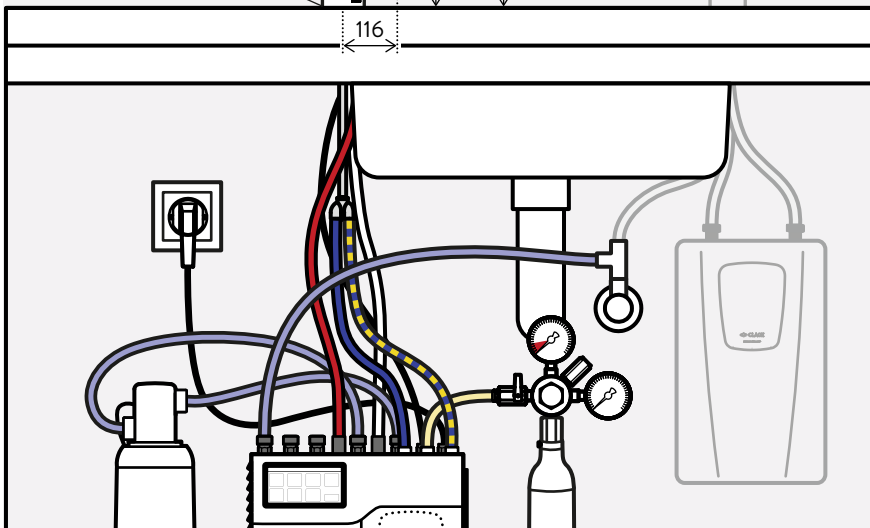

Installation at the kitchen sink



Installation as stand-alone unit with drainage front and extension KXTV.



Water system Zip HydroTap® G5 BCS Installation

Option 2: Tap "Arc BCS"

Measurements in mm

For the operation of the water system Zip HydroTap® G5 BCS you need a suitable tap, for example the tap "Arc BCS".

Assembly and operating instructions must be observed upon installation.

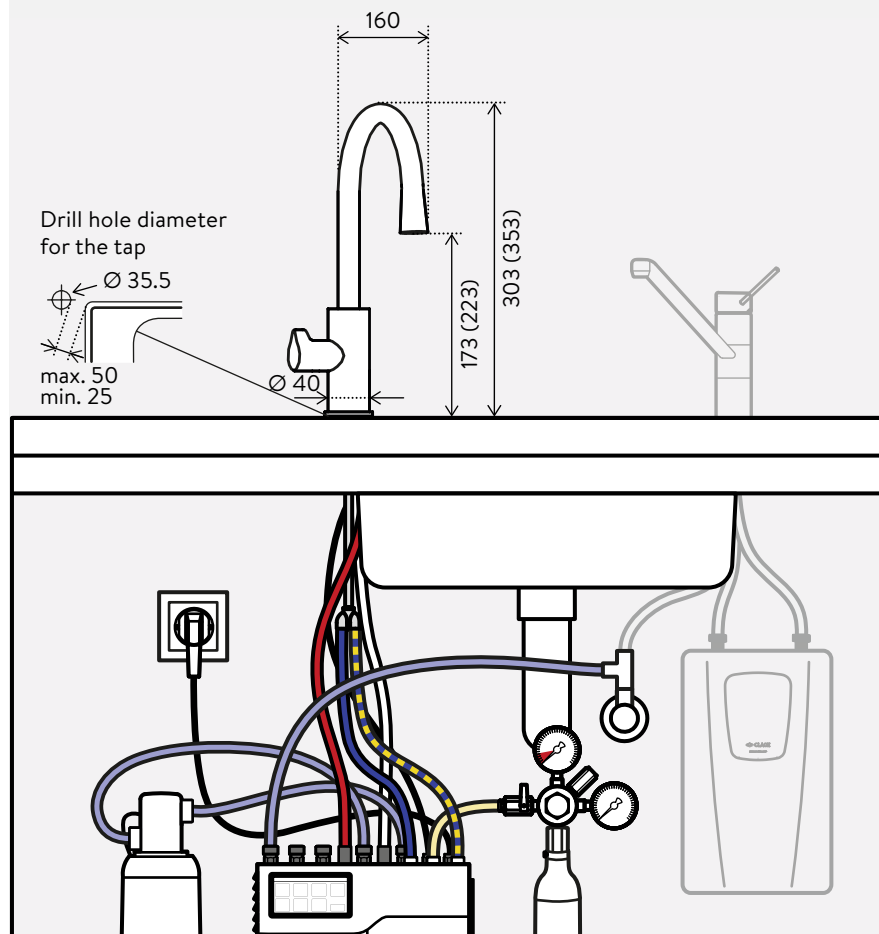

Flexible alignment

The Arc can be installed for left and right hand operation and the pipe outlet can be fixed at various angles and heights.

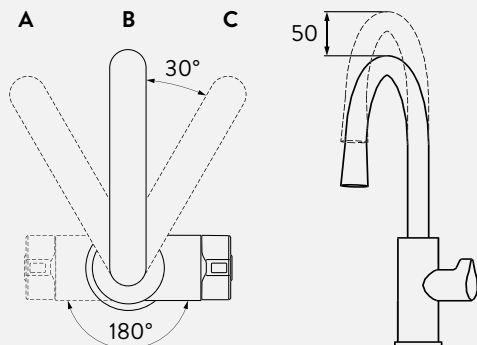

Installation as stand-alone unit with drainage font KXT.



Water system

Zip HydroTap® G5 BCS

Installation

Option 3: Tap "Celsius Arc AIO All-In-One"

Measurements in mm

For the operation of the water system Zip HydroTap® G5 BCS you need a suitable tap, for example the tap "Celsius Arc AIO All-In-One".

Assembly and operating instructions must be observed upon installation.

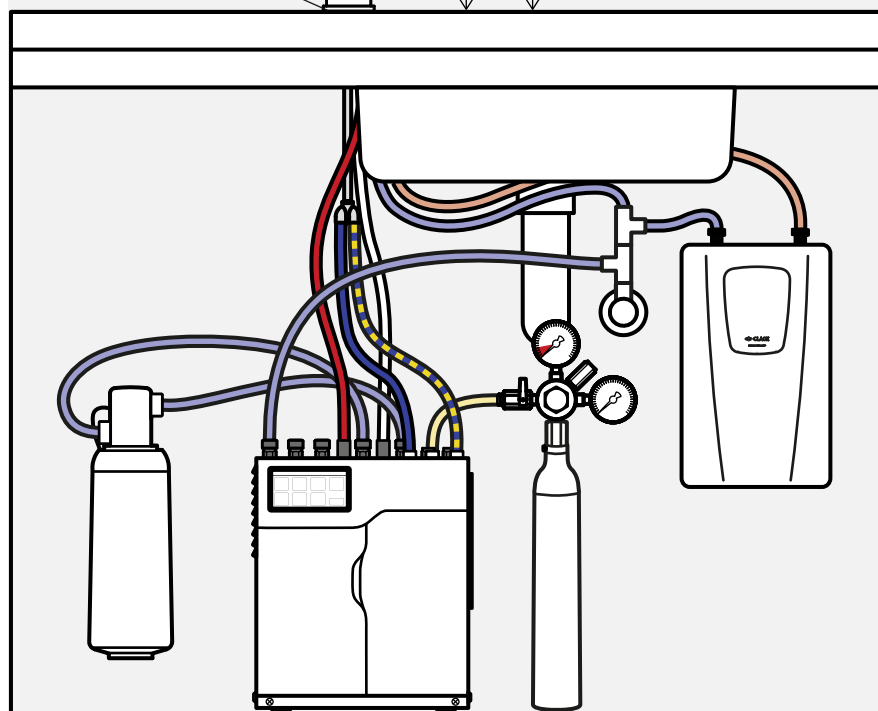
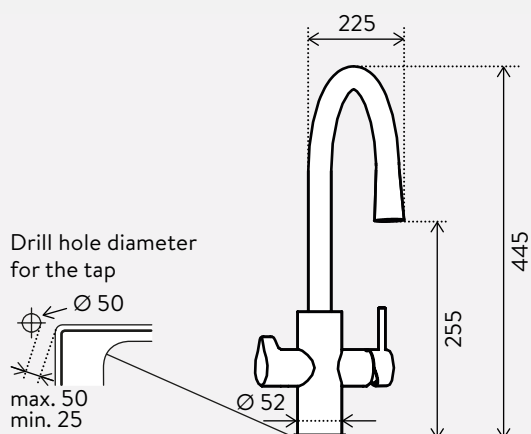

Note:

With this tap, both the water connections of the normal water supply (hot and cold water pipes) and the connections of the water system are connected to the tap.

Water system

Zip HydroTap® G5 BCS Taps



Zip Classic BCS

Electronic dispensing tap for Zip HydroTap® BCS with operating keys at the top, function indicator, holding function for easy canister filling, fixed spout 12 cm, height 21 cm, drill hole with 35 mm diameter required.

Classic BCS, polished chrome: Part no. 4100-44500
Classic BCS, brushed chrome: Part no. 4100-44501
Classic BCS, matte black: Part no. 4100-44502



Zip Classic Plus BCS

Electronic dispensing tap for Zip HydroTap® BCS with operating keys at the top, function indicator, fill button for easy canister filling, fixed spout 12 cm, height 21 cm, drill hole with 35 mm diameter required.

Classic Plus BCS, polished chrome: Part no. 4100-44800
Classic Plus BCS, brushed chrome: Part no. 4100-44801
Classic Plus BCS, matte black: Part no. 4100-44802



Zip Touch-Free BCS

Electronic dispensing tap for Zip HydroTap® B with IR sensors and function indicator for hygienic, no-touch operation, free space of min. 10 cm around the sensor head needed, fixed spout 12 cm, height 21 cm, drill hole with 35 mm diameter required.

Touch-Free BCS, polished chrome: Part no. 4100-44540

Water system

Zip HydroTap® G5 BCS

Taps



Zip Arc BCS

Electronic dispensing tap for Zip HydroTap® BCS with operating lever on the side, function indicator, holding function for easy canister filling, fixed spout 16 cm, height 35.3 cm, drill hole with 35 mm diameter required.

Arc BCS, polished chrome: Part no. 4100-44503
Arc BCS, brushed chrome: Part no. 4100-44504
Arc BCS, matte black: Part no. 4100-44505



Zip Celsius Arc AIO "All-In-One"

Electronic all-round tap for Zip HydroTap® BCS with two tapping options: a side control button for tapping the types of drinking water provided by the undersink unit BCS (boiling, chilled, sparkling) and a single-lever mixer for tapping normal tap water from the central or decentralised hot water supply. With function indicator, holding function for convenient can filling, swivel spout 22 cm, height 44 cm, drill hole with 50 mm diameter required.

Celsius Arc AIO, polished chrome: Part no. 4100-44524
Celsius Arc AIO, brushed chrome: Part no. 4100-44525
Celsius Arc AIO, matte black: Part no. 4100-44526



KXV for Classic (optional)

The optional extension for raising the electronic dispensing tap Zip Classic by 13.5 cm.

KXV , polished chrome:	Part no. 4100-44165
KXV , brushed chrome:	Part no. 4100-44166
KXV , matte black:	Part no. 4100-44167



KXTV for Classic (optional)

The optional stainless steel font with drainage connection and extension allows for flexible installation of the electronic dispensing tap at any location away from the sink. Suitable for worktops and surfaces up to 40 mm thick.

KXTV , polished chrome:	Part no. 4100-44565
KXTV , brushed chrome:	Part no. 4100-44566
KXTV , matte black:	Part no. 4100-44567



KXTV Pro for Classic / Classic Plus / Touch-Free (optional)

The optional stainless steel font with drainage connection and extension allows for flexible installation of the electronic dispensing tap at any location away from the sink. Suitable for worktops and surfaces up to 40 mm thick.

KXTV Pro , polished chrome:	Part no. 4100-44570
KXTV Pro , brushed chrome:	Part no. 4100-44571
KXTV Pro , matte black:	Part no. 4100-44572

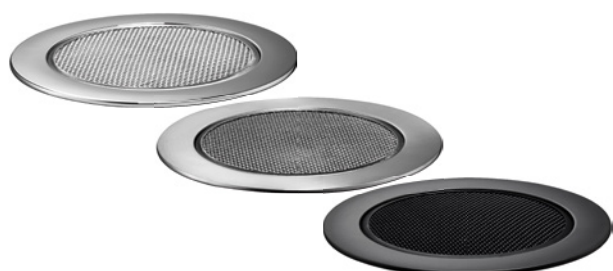

KXT for Arc (optional)

The optional stainless steel font with drainage connection allows for flexible installation of the electronic dispensing tap at any location away from the sink. Suitable for worktops and surfaces up to 40 mm thick.

KXT , polished chrome:	Part no. 4100-44560
KXT , brushed chrome:	Part no. 4100-44561
KXT , matte black:	Part no. 4100-44562



KXF 2.1 (included)

Sub-micron particle filter cartridge filters contaminants > 0.2 microns and additionally improves the taste of the water.
For Zip HydroTap® G4 models from 02.2017.

KXF 2.1: Part no. 893702

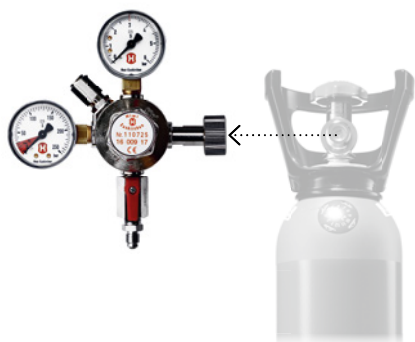

DMBCS

Pressure reducer with standard CO₂ connecting thread (½ inch), gas cylinders can be obtained via specialist gas suppliers

DMBCS: Part no. 4100-44120



DMSP

Pressure reducer with Soda Club connecting thread.

DMSP: Part no. 4100-44125

COF (only available for dispatch within Germany)

CO₂ gas cylinder (charge 425g) for Soda Club connecting thread.

COF: Part no. 9910-90005



Filter system CLARIS ULTRA for water softening (optional)

For hard, chalky water, the filter system CLARIS ULTRA is to be used (recommended from 10°KH).

Filter head suitable for all CLARIS ULTRA-filter

Filter head Universal: Part no. 84519

Filter cartridge, capacity at 10°KH 4.200 litre

CLARIS ULTRA 500: Part no. 84500

Filter cartridge, capacity at 10°KH 8.500 litre

CLARIS ULTRA 1000: Part no. 84501

Filter cartridge, capacity at 10°KH 20.000 litre

CLARIS ULTRA 2000: Part no. 84502

Water system
Zip HydroTap® G5 BCS
Accessories



DTK (optional)

The digital temperature controller for Zip devices is used to keep the temperature in the cupboard below 35 °C when normal ventilation is not sufficient. The digital controller operates independently of the undersink unit and will require a separate 230 V socket.

DTK: Part no. 893159