

Produktdatenblatt
Leerflasche 805.06.E03

HEWI

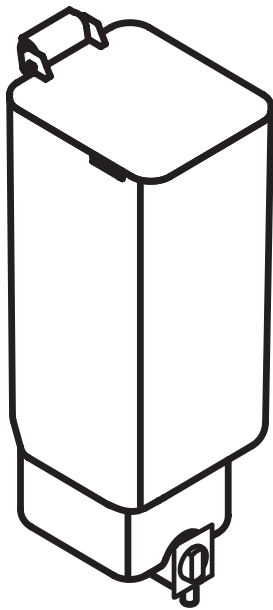

Leerflasche 805.06.E03

- für Seifenspender 805.06.100, 950.06.100
- inkl. Lotionpumpe
- aus Kunststoff, 600 ml



Abmessungen in mm

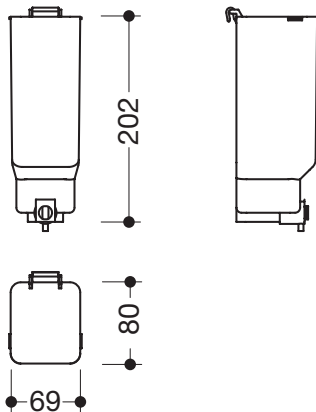

Technische Änderungen vorbehalten, 14.08.2019

HEWI Heinrich Wilke GmbH
Postfach 1260
D-34442 Bad Arolsen

Telefon: +49 5691 82-0
Telefax: +49 5691 82-319

info@hewi.de
www.hewi.com