

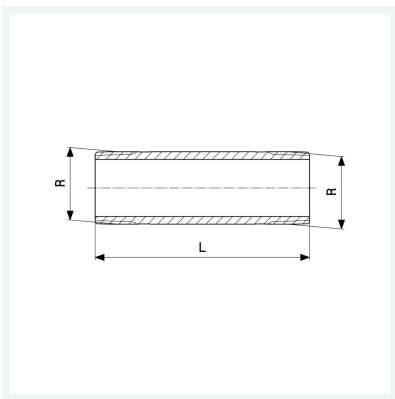

Langnippel
- R-Gewinde
Modell 3530

Artikel 650 896



Eigenschaften

Länge	L	50
Außengewinde kegelig	R	½
Länge	L	50 mm
Gewicht	73,6 g	
Volumen	82,88 cm ³	
Werkstoff	Rotguss oder Siliziumbronze	