



Profipress G-Schiebemuffe mit SC-Contur

- Pressanschlüsse

Ausstattung

Dichtelemente HNBR

Modell 2615.5

Artikel 394 165

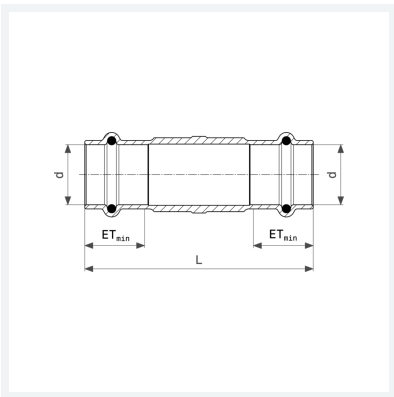

Eigenschaften

Rohraußendurchmesser	d	15
Länge	L	80 mm
Einstecktiefe minimal	ETmin	22 mm
Gewicht	83,3 g	
Volumen	82,88 cm ³	
Werkstoff	Rotguss	