

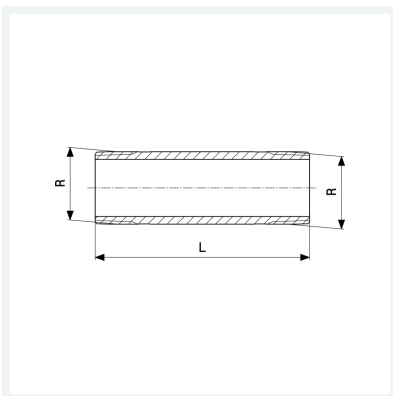

Langnippel
- R-Gewinde
Modell 3530

Artikel 319 717



Eigenschaften

Länge	L	160
Außengewinde kegelig	R	½
Länge	L	160 mm
Gewicht	276,24 g	
Volumen	155,4 cm ³	
Werkstoff	Rotguss oder Siliziumbronze	